

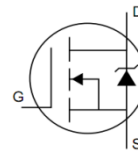

Product Summary

It combines advanced trench MOSFET technology with a low resistance package to provide extremely low $R_{DS(ON)}$.



=

Trench technology

$R_{DS(ON)}$ to minimize conductive loss

nd Synchronous Rectifier

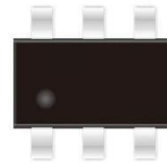

Part NO.	ZM095N03U
Marking	095N03
Packing Information	REEL TAPE
Basic ordering unit (pcs)	3000

$T_C = 25$

Parameter	Symbol	Rating	Unit
Drain-Source Voltage	V_{DS}	30	V
Gate-Source Voltage	V_{GS}	± 20	V
Continuous Drain Current	$I_{D@TC=25}$	8	A
	$I_{D@TC=75}$	6	A
	$I_{D@TC=100}$	5	A
Pulsed Drain Current	I_{DM}	24	A
Total Power Dissipation	$P_D@TC=25$	2.1	W
Total Power Dissipation($T_A=25$)	$P_D@T_A=25$	1.25	W
Operating Junction Temperature	T_J	-55 to 150	
Storage Temperature	T_{STG}	-55 to 150	

**Thermal resistance**

Parameter	Symbol	Min.	Typ.	Max.	Unit
Thermal resistance, junction - case	R_{thJC}	-	-	60	C/W
Thermal resistance, junction - ambient	R_{thJA}	-	-	100	C/W
Soldering temperature, wavesoldering for 10s	T_{sold}	-	-	265	C

Parameter	Symbol	Condition	Min.	Typ.	Max.	Unit
Drain-Source Breakdown Voltage	BV_{DSS}	$V_{GS} = 0V, I_D = 250\mu A$	30			V

Gate Threshold Voltage



Fig.1 Gate-Charge Characteristics

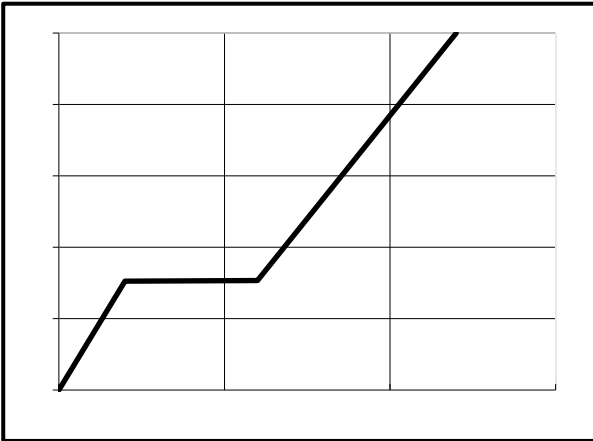

Fig.2 Capacitance Characteristics

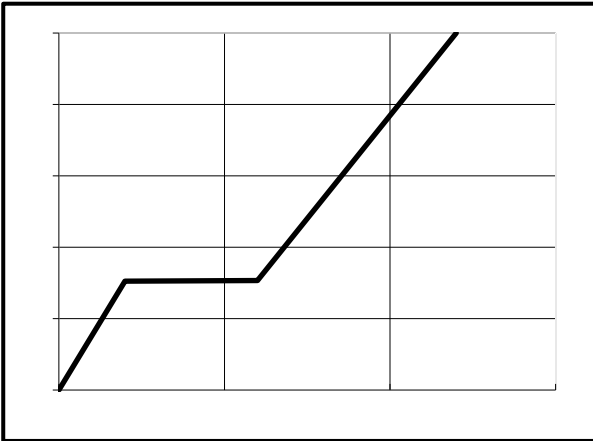

Fig.3 Power Dissipation Derating Curve

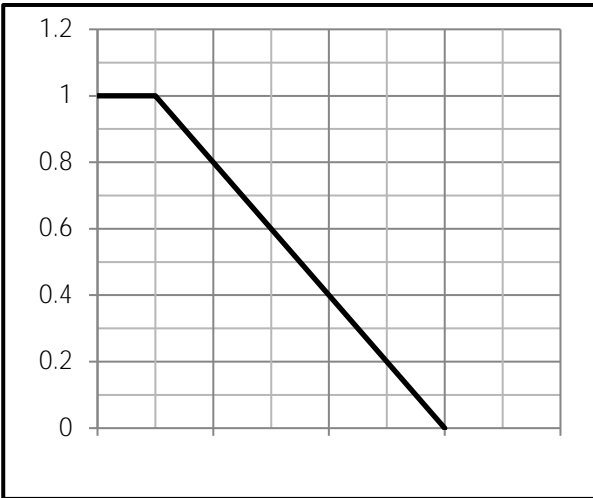

Fig.4 Typical output Characteristics

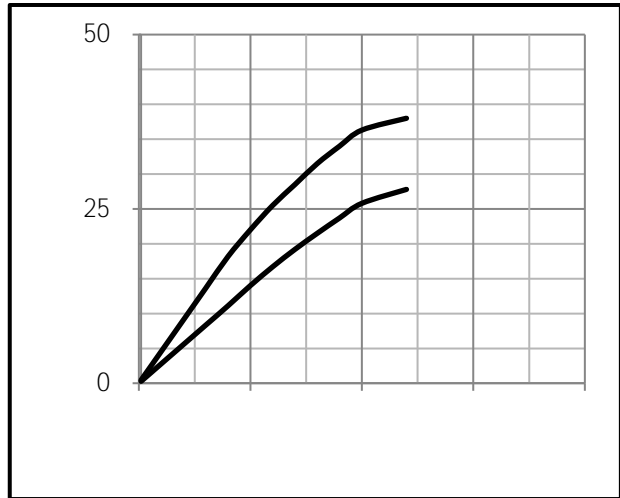

Fig.5 Threshold Voltage V.S Junction Temperature



Fig.6 Resistance V.S Drain Current



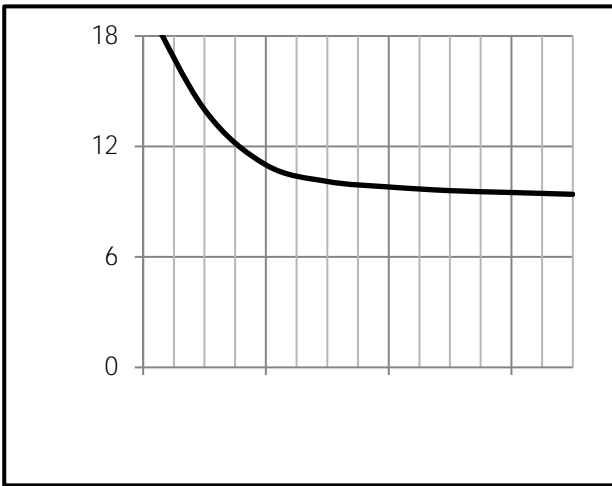

Fig.9 Switching Time Measurement Circuit

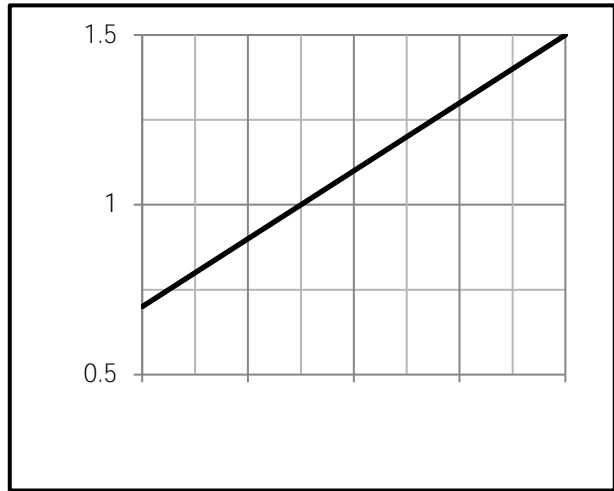

Fig.10 Gate Charge Waveform

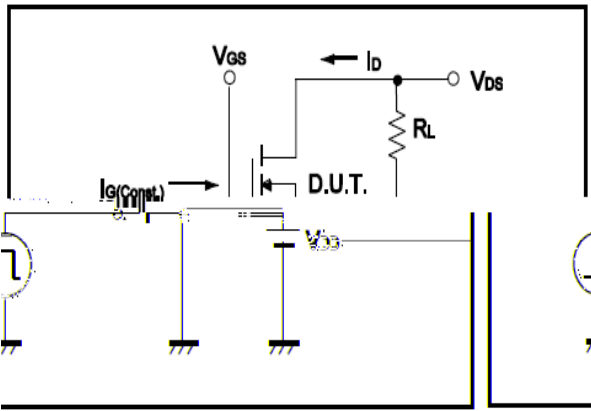

Fig.11 Switching Time Measurement Circuit

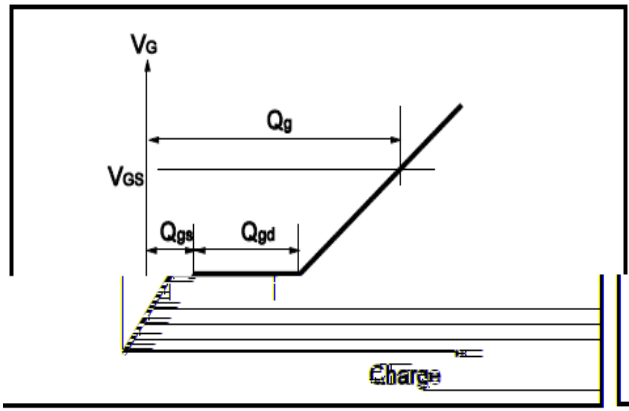
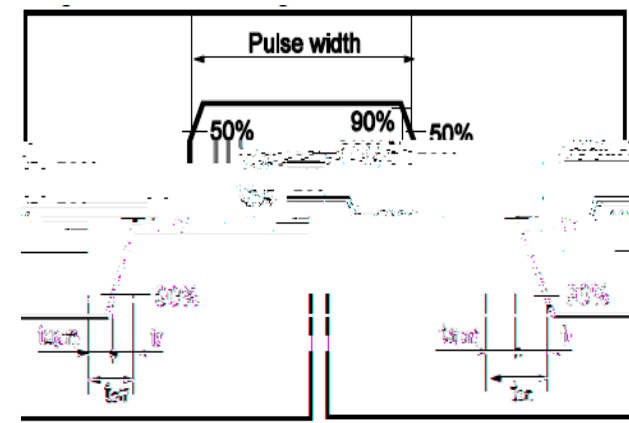
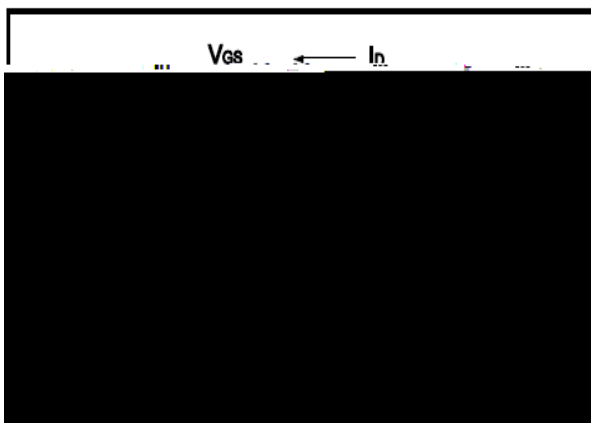

Fig.12 Gate Charge Waveform





(SOT23-6)

Unit: mm

