

**General Description**

The ZM040N06HN combines advanced trench MOSFET technology with a low resistance package to provide extremely low $R_{DS(ON)}$.

Features

Trench technology
 $R_{DS(ON)}$ to minimize conductive loss

Product Summary**Application**

Synchronous Rectification for AC-DC/DC-DC converter
 Oring switches

Ordering Information:**Absolute Maximum Ratings** $T_C = 25$

Parameter	Symbol	Rating	Unit
Drain-Source Voltage	V_{DS}	60	V
Gate-Source Voltage	V_{GS}	± 20	V
Continuous Drain Current	$I_{D@TC=25}$	100	A
	$I_{D@TC=75}$	76	A
	$I_{D@TC=100}$	63	A
Pulsed Drain Current	I_{DM}	260	A
Total Power Dissipation($TC=25$)	$P_D@TC=25$	85	W
Total Power Dissipation($TA=25$)	$P_D@TA=25$	3.4	W
Operating Junction Temperature	T_J	-55 to 150	
Storage Temperature	T_{STG}	-55 to 150	
Single Pulse Avalanche Energy@ $L=0.1mH$	E_{AS}	180	mJ
Avalanche Current@ $L=0.1mH$	I_{AS}	60	A



Thermal resistance

Parameter	Symbol	Min.	Typ.	Max.	Unit
-----------	--------	------	------	------	------

Gate-Charge Characteristics

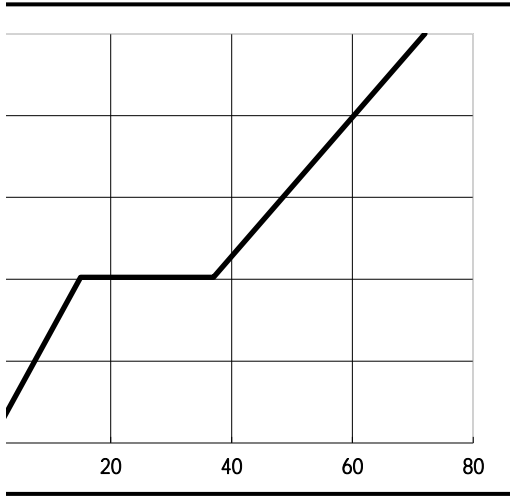
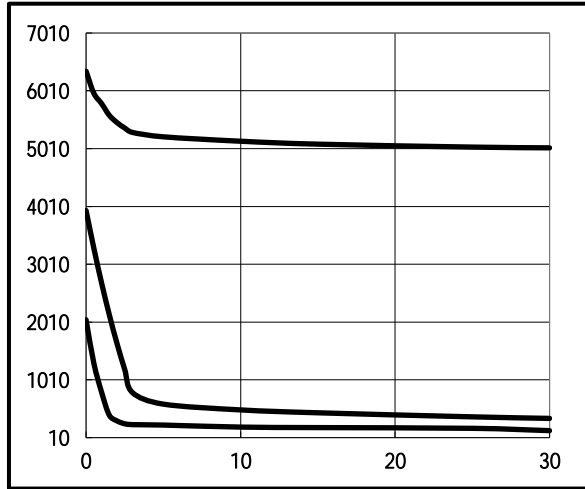

Fig.2 Capacitance Characteristics



Power Dissipation

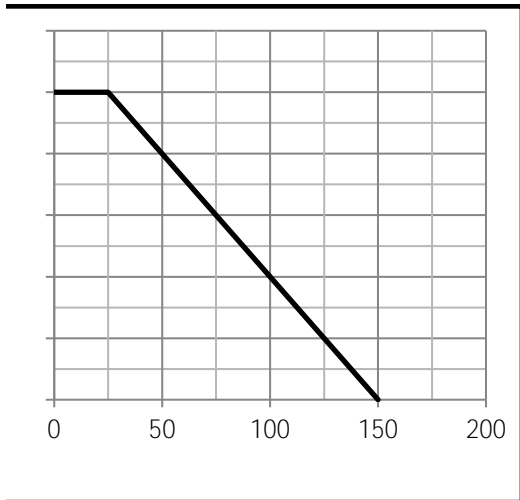
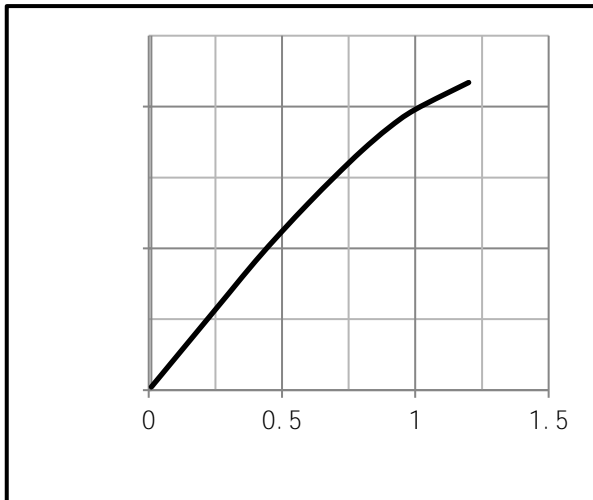

Fig.4 Typical output Characteristics



Threshold Voltage V.S Junction Temperature

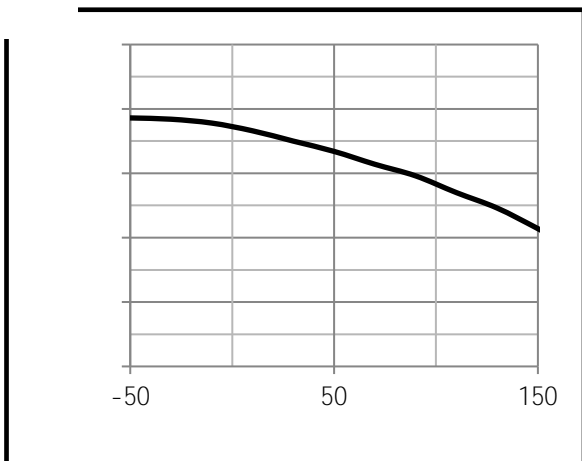

Fig.6 Resistance V.S Drain Current





Fig.7 On-Resistance VS Gate Source Voltage

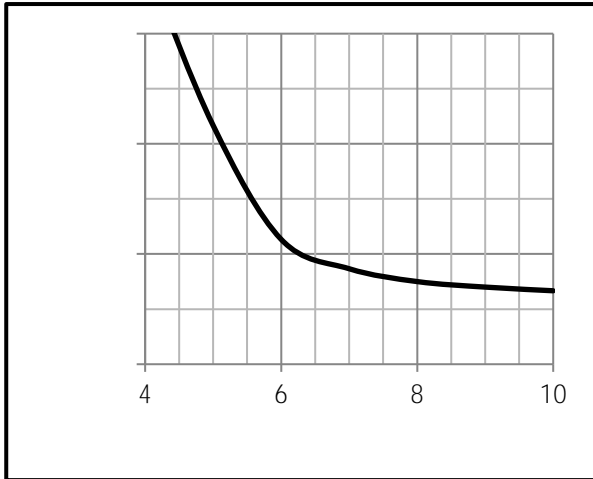

Fig.8 On-Resistance V.S Junction Temperature

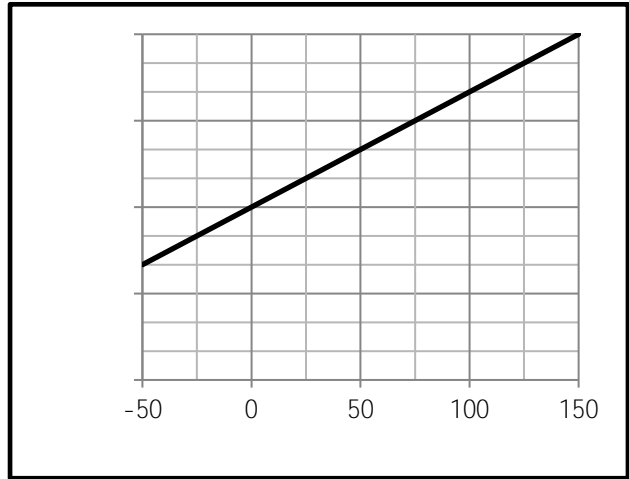

Fig.9 Switching Time Measurement Circuit

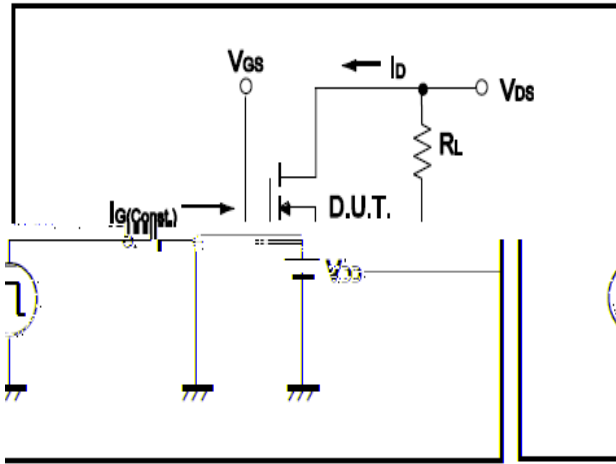

Fig.10 Gate Charge Waveform

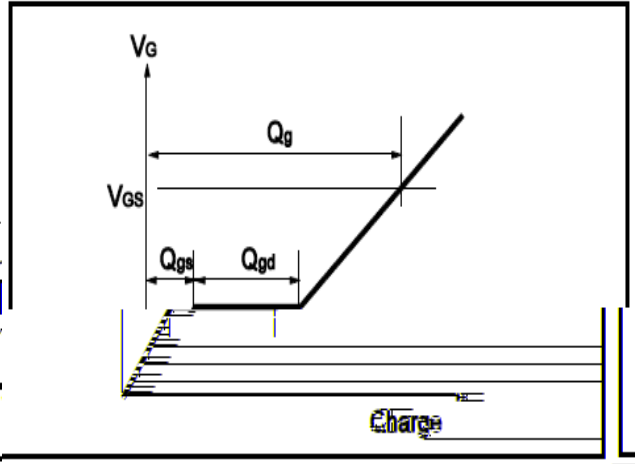

Fig.11 Switching Time Measurement Circuit

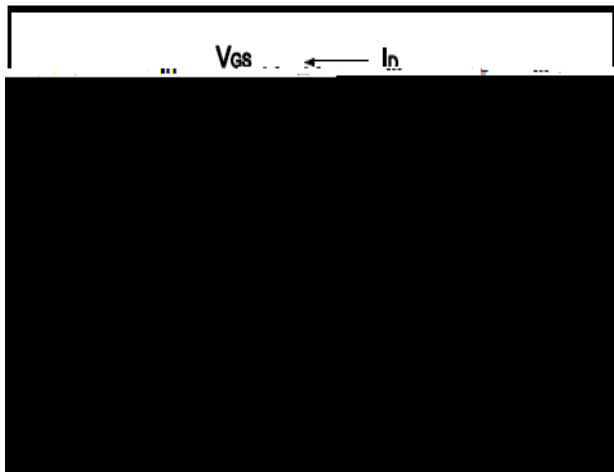
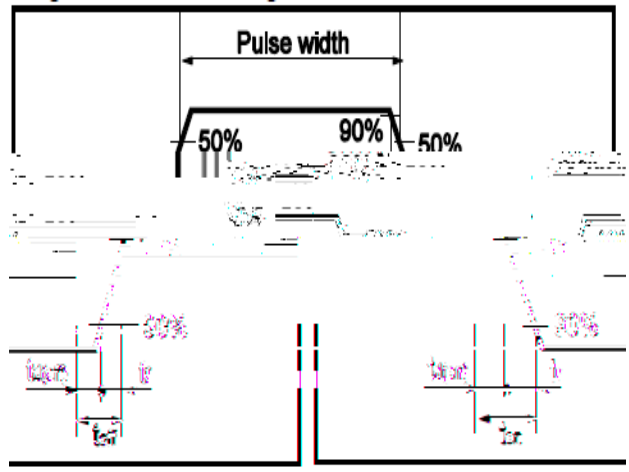

Fig.12 Gate Charge Waveform





Dimensions DFN5x6

Unit mm

