



Product Description

The ZM098N06N combines advanced trench MOSFET technology with a low resistance package to provide extremely low $R_{DS(ON)}$.

Key Features

- Trench technology $R_{DS(ON)}$ to minimize conductive loss

Applications

• Synchronous Rectifier

Product Summary



$V_{DS} = 60V$

$R_{DS(ON)} = 10m\Omega$

$I_D = 50A$

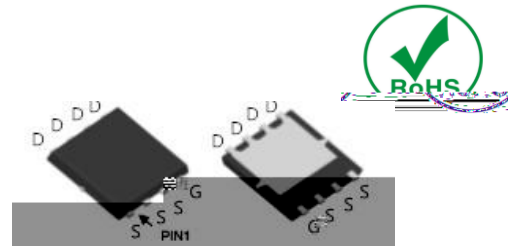

DFN56

Ordering Information

Part NO.	ZM098N06N
Marking	ZM098N06
Packing Information	REEL TAPE
Basic ordering unit (pcs)	3000

Electrical Characteristics $T_C = 25^\circ C$

Parameter	Symbol	Rating	Unit
Drain-Source Voltage	V_{DS}	60	V
Gate-Source Voltage	V_{GS}	± 20	V
Continuous Drain Current	$I_{D@TC=25}$	50	A
	$I_{D@TC=75}$	38	A
	$I_{D@TC=100}$	31	A
Pulsed Drain Current	I_{DM}	150	A
Total Power Dissipation($TC=25^\circ C$)	$P_D@TC=25$	70	W
Total Power Dissipation($TA=25^\circ C$)	$P_D@TA=25$	2.8	W
Operating Junction Temperature	T_J	-55 to 150	
Storage Temperature	T_{STG}	-55 to 150	
Avalanche Current	$I_{AS} I_{AR}$	40	A

Fig.1 Gate-Charge Characteristics

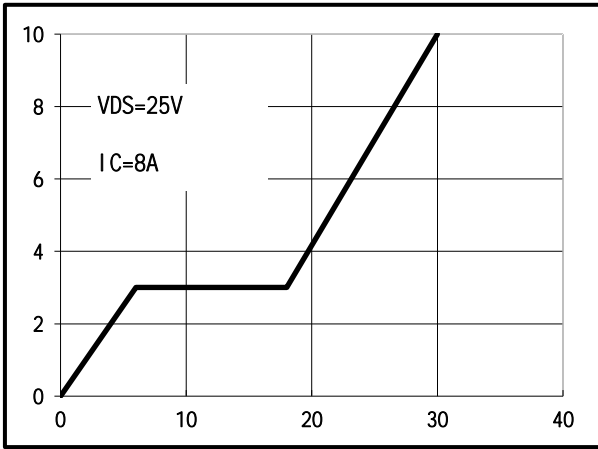

Fig.2 Capacitance Characteristics

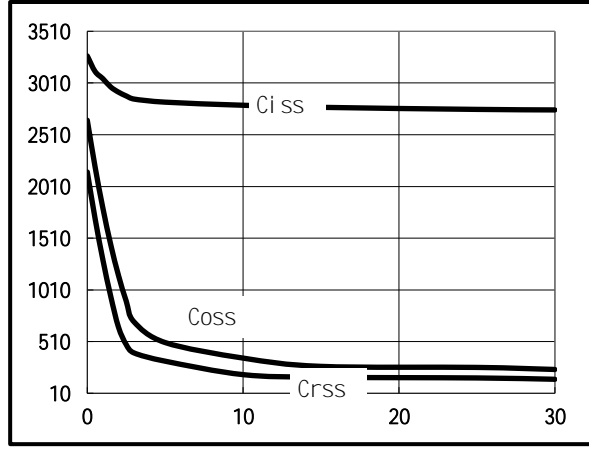

Fig.3 Power Dissipation

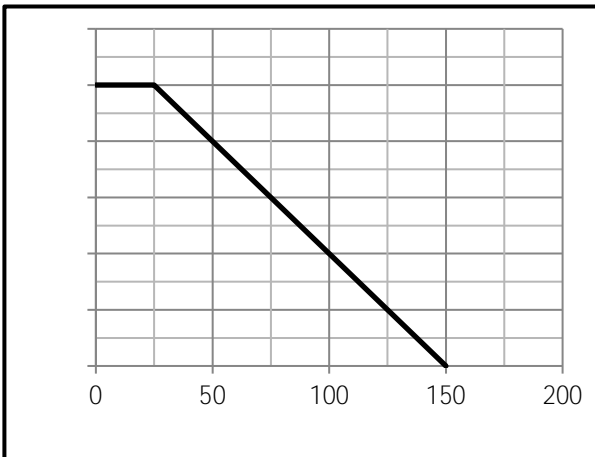

Fig.4 Typical output Characteristics

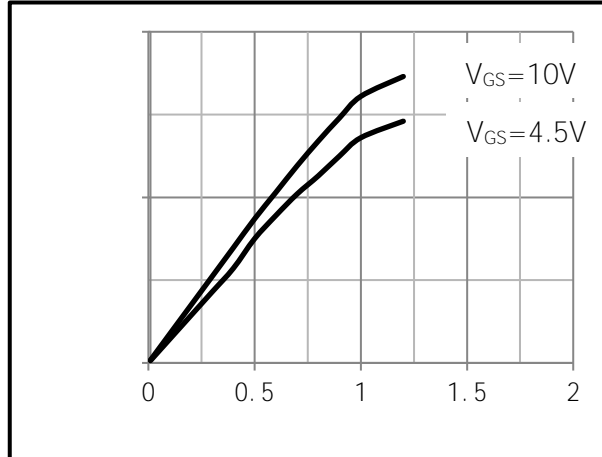

Fig.5 Threshold Voltage V.S Junction Temperature

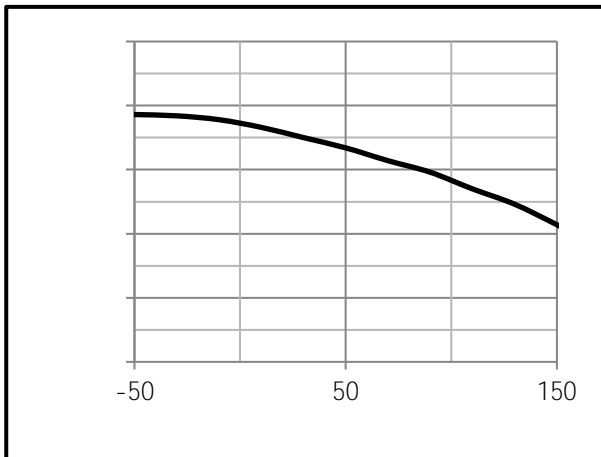

Fig.6 Resistance V.S Drain Current

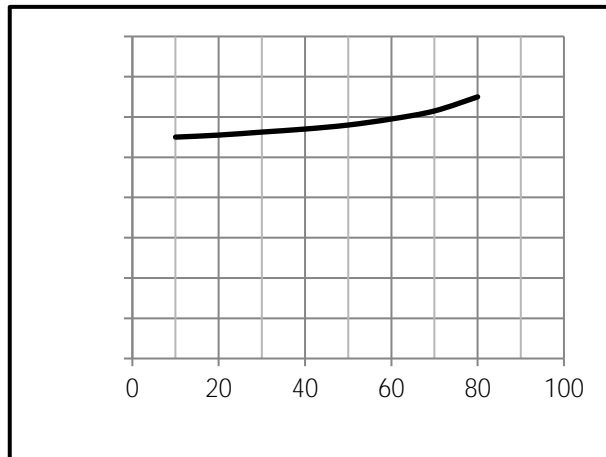



Fig.7 On-Resistance VS Gate Source Voltage

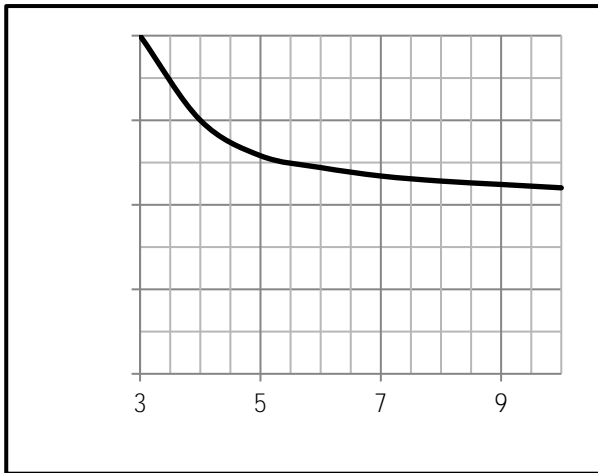

Fig.8 On-Resistance V.S Junction Temperature

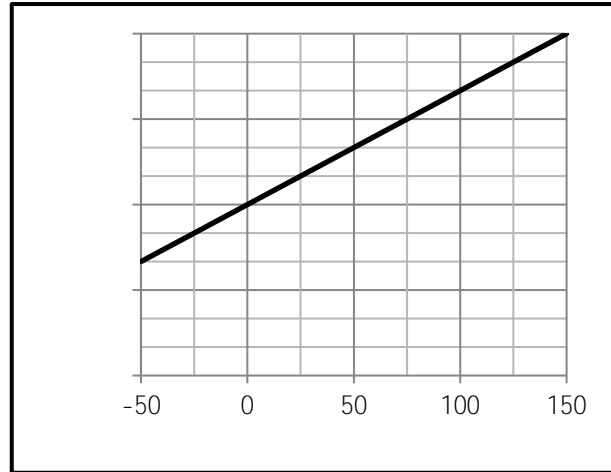

Fig.9 Switching Time Measurement Circuit

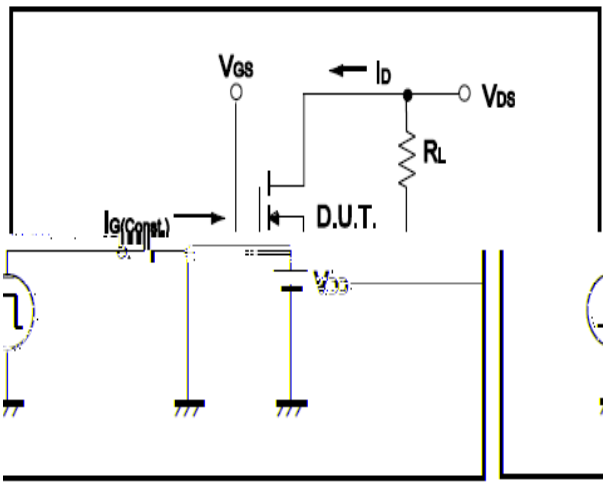

Fig.10 Gate Charge Waveform

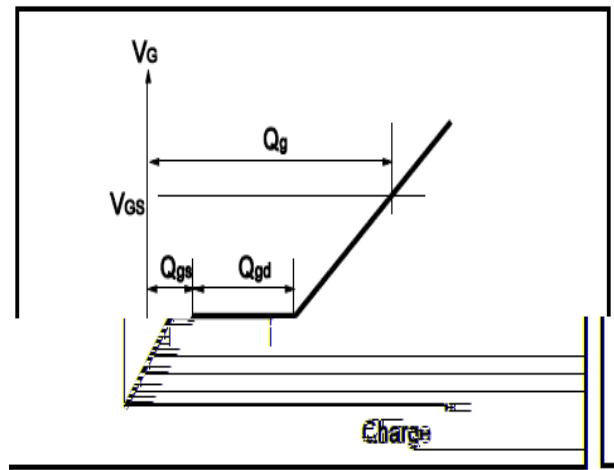

Fig.11 Switching Time Measurement Circuit

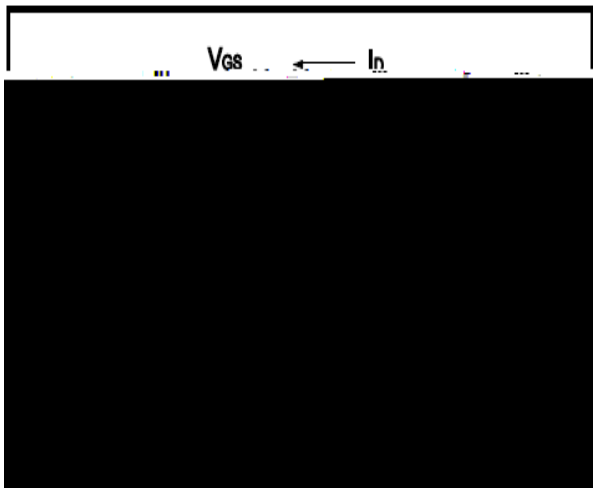

Fig.12 Gate Charge Waveform

