



General Description

The ZM100N02D combines advanced trench MOSFET technology with a low resistance package to provide extremely low $R_{DS(ON)}$. This device is ideal for load switch and battery protection applications.

Features

Advance high cell density Trench technology
 $R_{DS(ON)}$ to minimize conductive loss

Application

nd Synchronous Rectifier

Product Summary



$V_{DS} = 20V$

$R_{DS(ON)} = 10m$

$I_D = 25A$

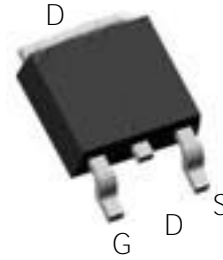

TO-252

Ordering Information:

Part NO.	ZM100N02D
Marking	ZM100N02
Packing Information	REEL TAPE
Basic ordering unit (pcs)	2500

Absolute Maximum Ratings $T_c = 25$

Parameter	Symbol	Rating	Unit
Drain-Source Voltage	V_{DS}	20	V
Gate-Source Voltage	V_{GS}	± 12	V
Continuous Drain Current	$I_{D@TC=25}$	25	A
	$I_{D@TC=75}$	19	A
	$I_{D@TC=100}$	15.8	A
Pulsed Drain Current	I_{DM}	60	A
Total Power Dissipation($TC=25$)	$P_D@TC=25$	85	W
Total Power Dissipation($TA=25$)	$P_D@TA=25$	3.5	W
Operating Junction Temperature	T_J	-55 to 150	
Storage Temperature	T_{STG}	-55 to 150	
Single Pulse Avalanche Energy@ $L=0.1mH$	E_{AS}	50	mJ





Fig.7 On-Resistance VS Gate Source Voltage

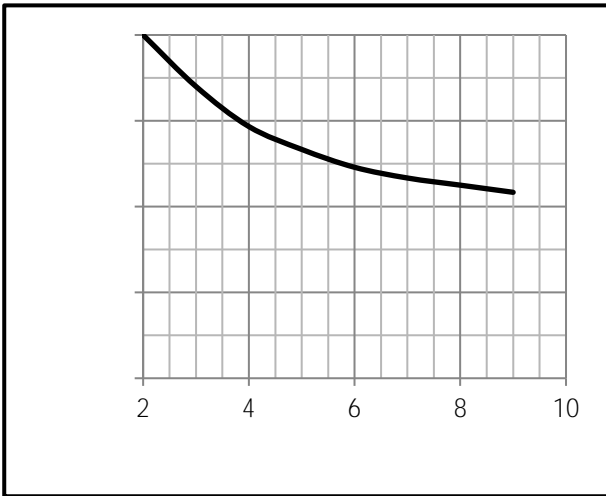

Fig.8 On-Resistance V.S Junction Temperature

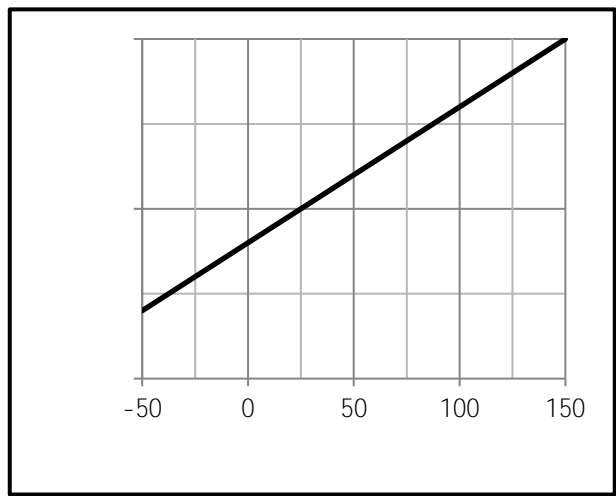

Fig.9 Switching Time Measurement Circuit

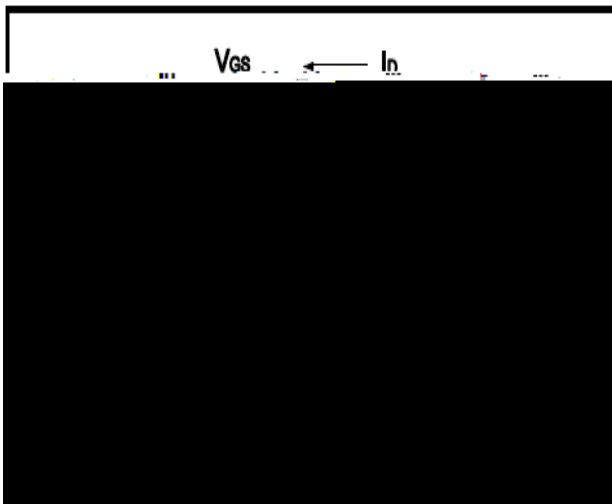

Fig.10 Gate Charge Waveform

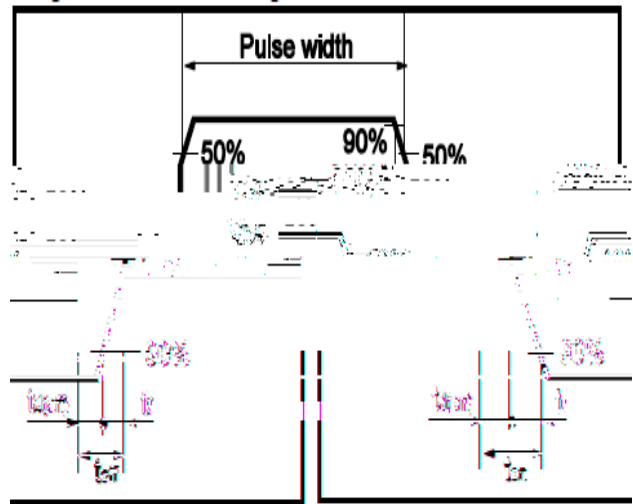

Fig.11 Avalanche Measurement Circuit

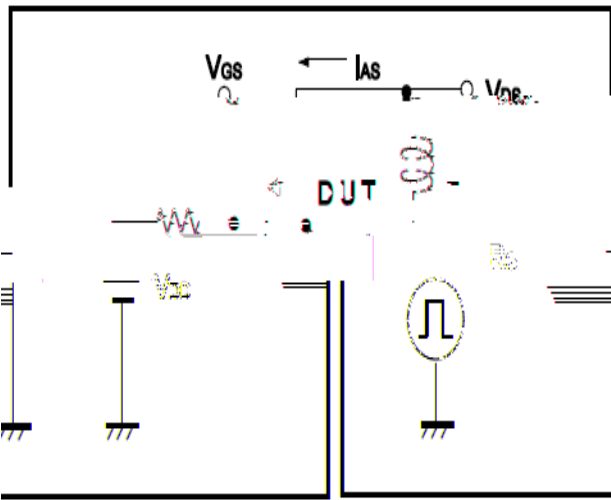
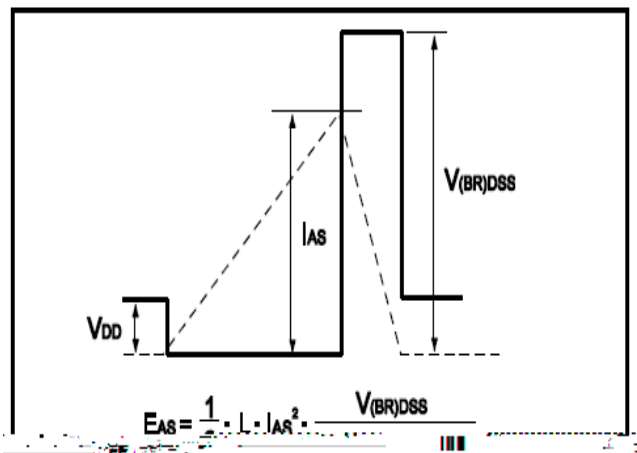

Fig.12 Avalanche Waveform





Dimensions (TO-252)

Unit mm

SYMBOL	mi n	max	SYMBOL	mi n	max
A	2.10	2.50	B	0.85	1.25
b	0.50	0.80	b1	0.50	0.90
b2	0.45	0.70	C	0.45	0.70
D	6.30	6.75	D1	5.10	5.50
E	5.30	6.30	e1	2.25	2.35
L1	9.20	10.60	e2	4.45	4.75
L2	0.90	1.75	L3	0.60	1.10
K	0.00	0.23			

