



□

Ordering Information:

□

Absolute Maximum Ratings $T_C = 25$

Parameter	Symbol	Rating	Unit
Drain-Source Voltage	V_{DS}	60	V
Gate-Source Voltage	V_{GS}	± 20	V
Continuous Drain Current	$I_{D@TC=25}$	35	A
	$I_{D@TC=75}$	26.6	A
	0.48001 0.4800		



Thermal resistance

	Symbol	Min.	Typ.	Max.	Unit
--	--------	------	------	------	------

Thermal resistance, junction - case



Fig.1 Power Dissipation

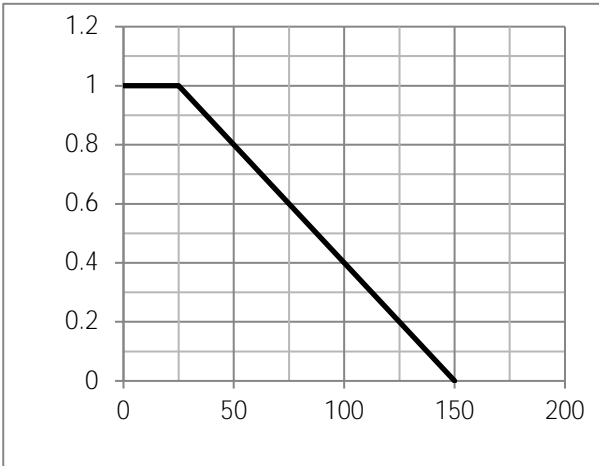

Fig.2 Typical output Characteristics

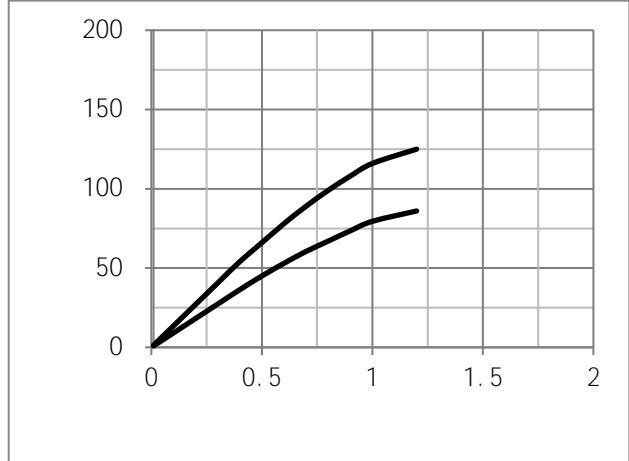

Fig.3 Threshold Voltage V.S Junction Temperature

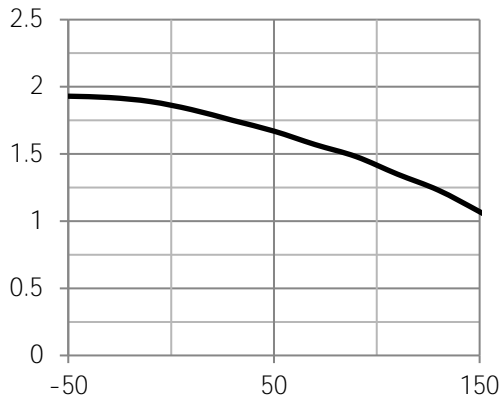

Fig.4 Resistance V.S Drain Current

Fig.7 Switching Time Measurement Circuit

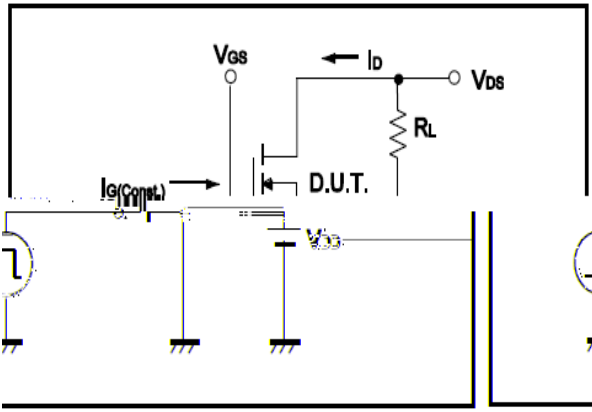

Fig.8 Gate Charge Waveform

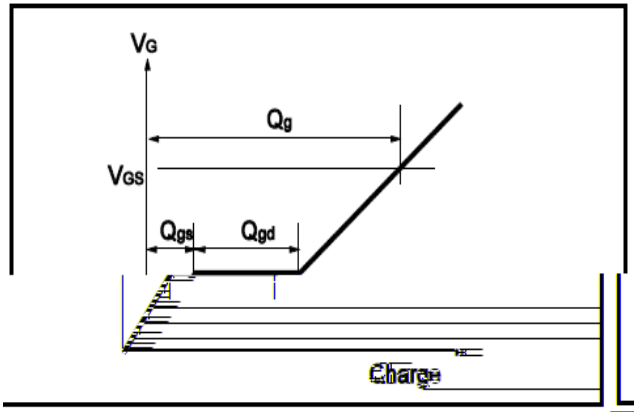

Fig.9 Switching Time Measurement Circuit

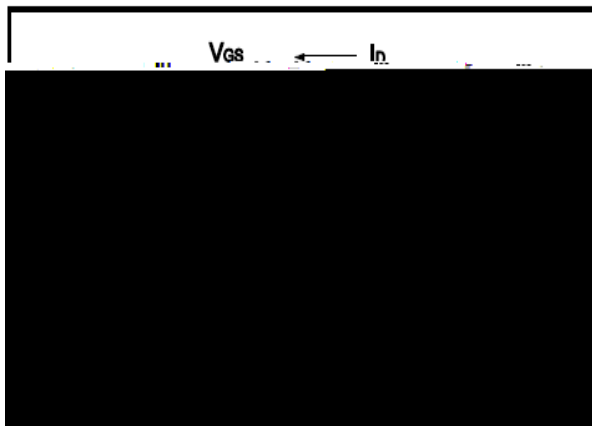

Fig.10 Gate Charge Waveform

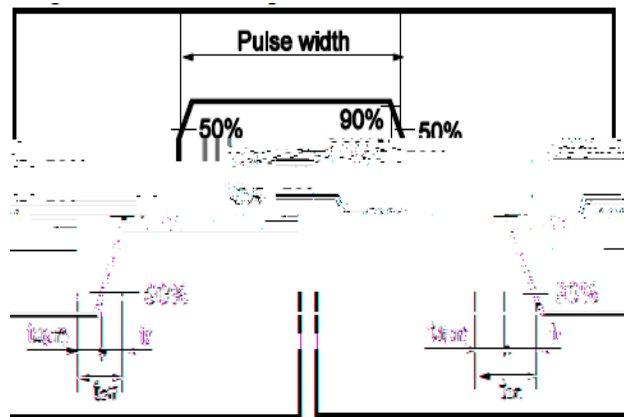

Fig.11 Avalanche Measurement Circuit

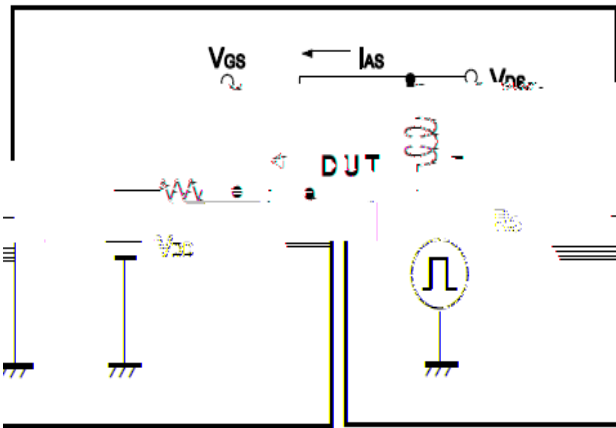
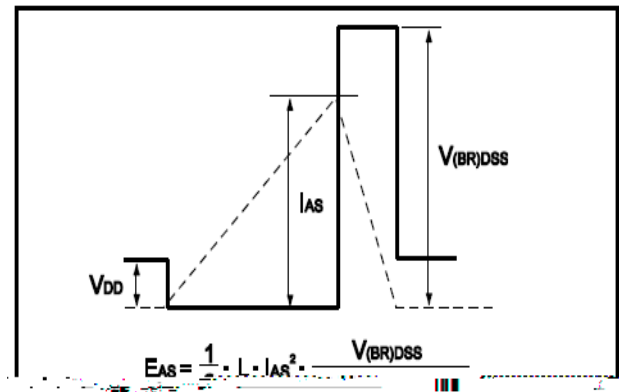

Fig.12 Avalanche Waveform





Dimensions (TO-220F)

Unit mm

Dimensions In Millimeters		Dimensions In Millimeters	
Min	Max	Min	Max
4.5	4.9	2.90	3.90
2.1	2.4	3.30	3.50
2.74	R	3.28	C1
2.95	b	12.46	13.78
			C2
			12.56

