



**Ordering Information:**

P r n ŌFU G H Uen-US

**Absolute M**



**Thermal resistance**

Parameter	Symbol	Min.	Typ.	Max.	Unit
Thermal resistance, junction - case	$R_{thJC}$	-	-	1.5	$^{\circ}C/W$

Fig.1 Gate-Charge Characteristics

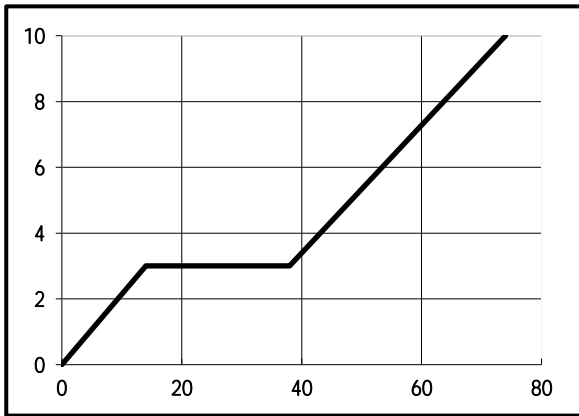

Fig.2 Capacitance Characteristics

Fig.3 Power Dissipation

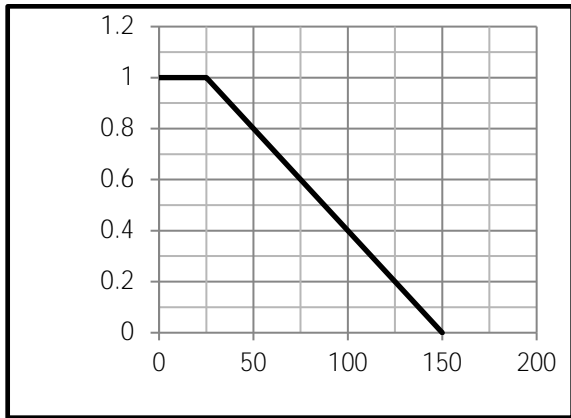

Fig.4 Typical output Characteristics

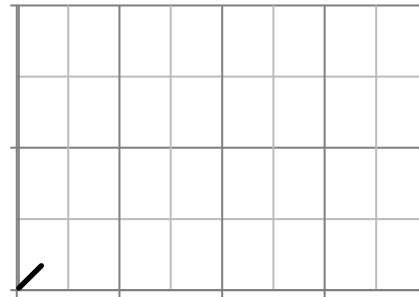
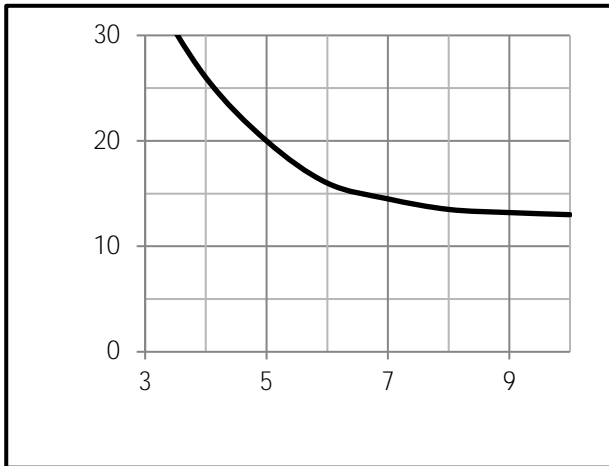

Fig.5 Threshold Voltage V.S Junction Temperature

Fig.6 Resistance V.S Drain Current

g On es stance S Gate Source o tage



g On es stance S unct on emperature

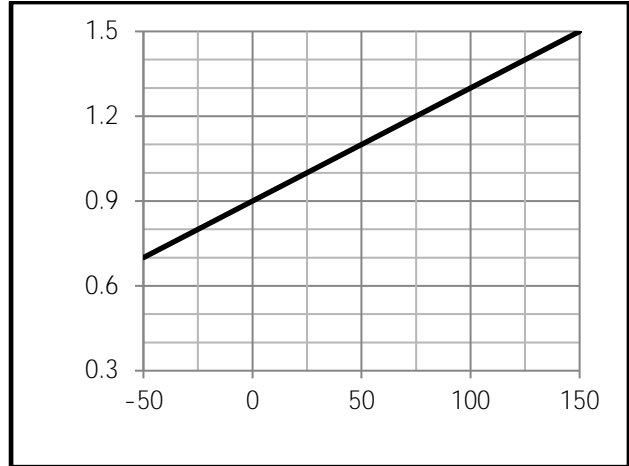

Fig.9 SOA Maximum Safe Operating Area

Fig.10 ID-Junction Temperature

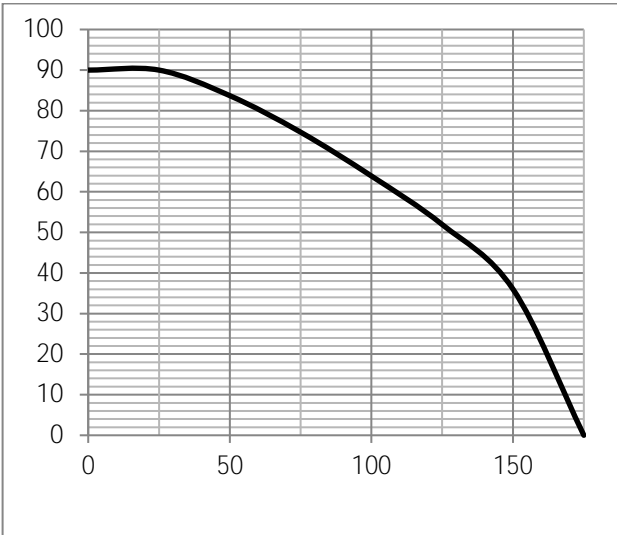
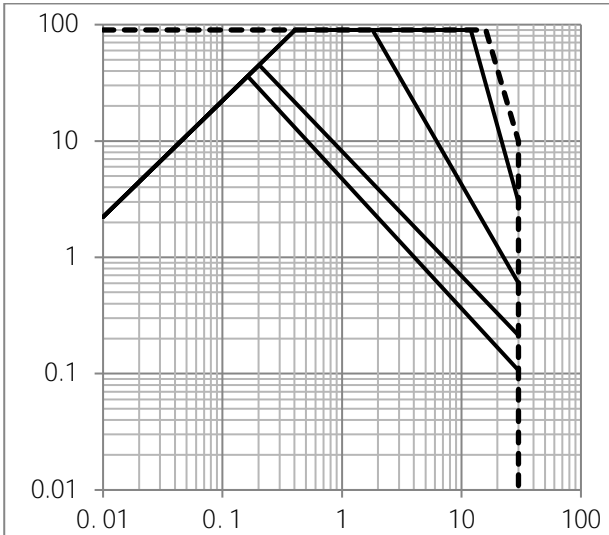
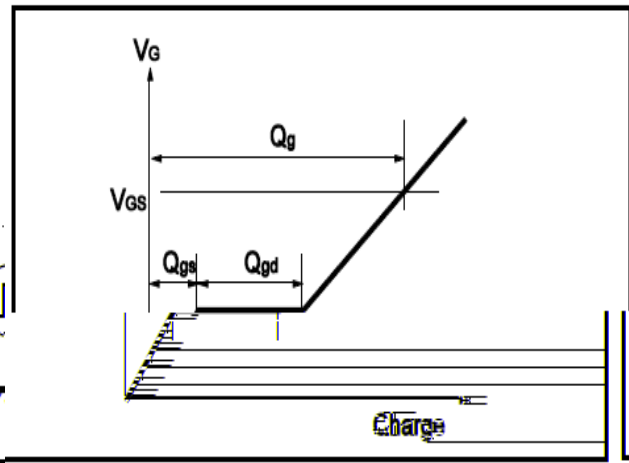
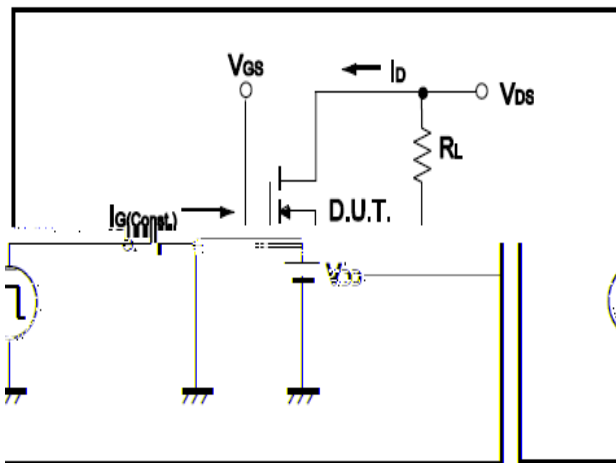

Fig.11 Switching Time Measurement Circuit

Fig.12 Gate Charge Waveform





**Dimensions(TO-251)**

Unit mm

SYMBOL	mi n	max	SYMBOL	mi n	max
A	2.10	2.50	D	6.35	6.80
A1	0.95	1.30	D1	5.10	5.50
B	0.80	1.25	E	5.30	6.30
b	0.50	0.80	e	2.24	2.35
b1	0.70	0.90	E1	4.43	4.73
c	0.45	0.60	L	7.00	9.40
c1	0.45	0.60			

