

General Description

The ZMD68202

Ordering Information:
Absolute Maximum Ratings $T_C = 25$

Parameter	Symbol	Rating	Unit
Drain-Source Voltage	V_{DS}	20	V
Gate-Source Voltage	V_{GS}	± 12	V
Continuous Drain Current	$I_{D@TC=25}$	9.0	A
	$I_{D@TC=75}$	7.0	A
	$I_{D@TC=100}$	5.6	A
Pulsed Drain Current	I_{DM}	13	A
Total Power Dissipation	$P_D@TC=25$	3.6	W
Total Power Dissipation	$P_D@TA=25$	0.69	W
Operating Junction Temperature	T_J	-55 to 150	
Storage Temperature	T_{STG}	-55 to 150	
Single Pulse Avalanche Energy	E_{AS}	30	mJ

Fig.1 Power Dissipation

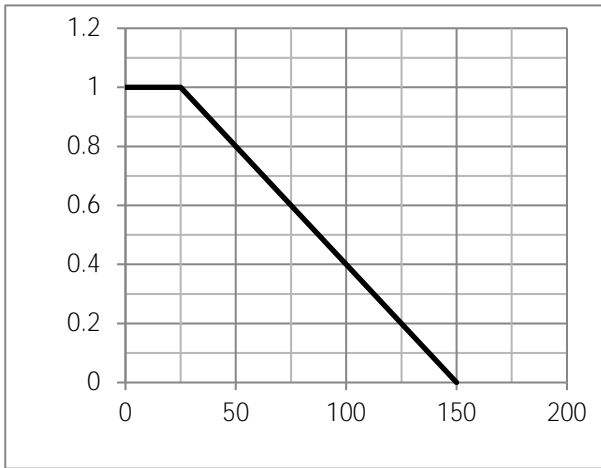

Fig.2 Typical output Characteristics

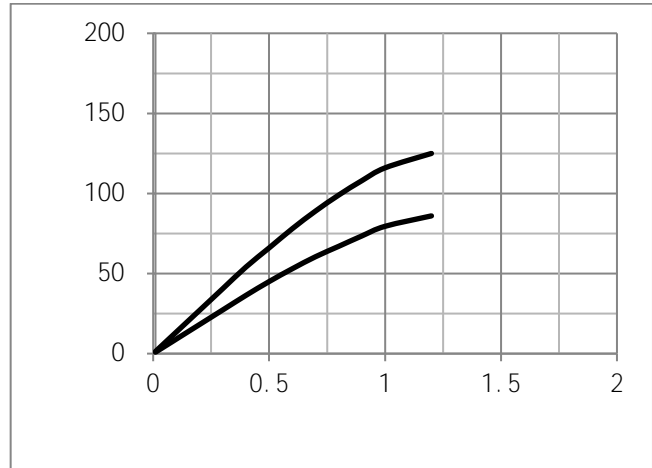

Fig.3 Threshold Voltage V.S Junction Temperature

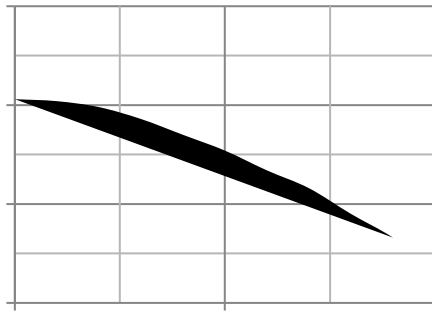

Fig.4 Resistance V.S Drain Current

Fig.7 Switching Time Measurement Circuit

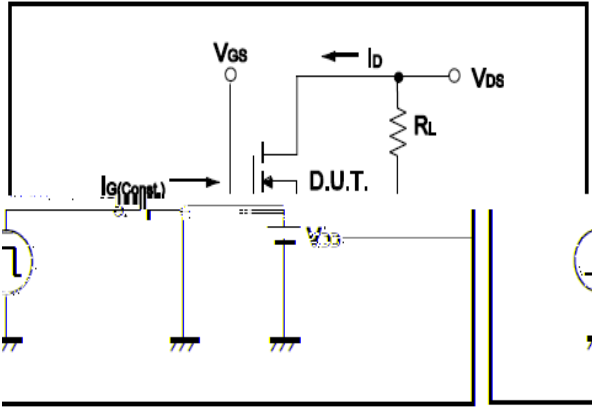

Fig.8 Gate Charge Waveform

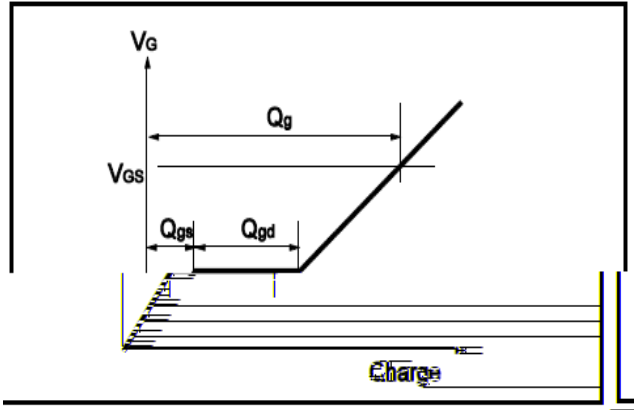

Fig.9 Switching Time Measurement Circuit

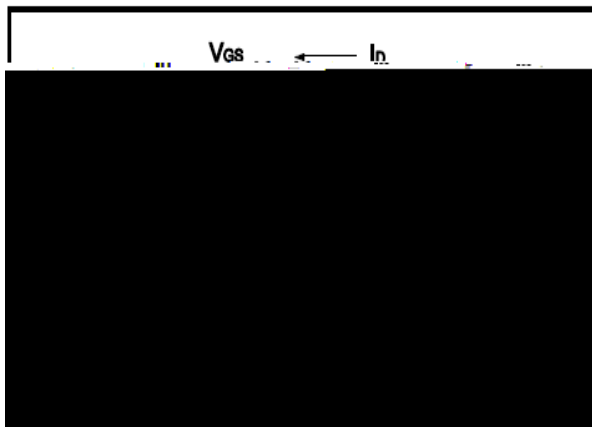

Fig.10 Gate Charge Waveform

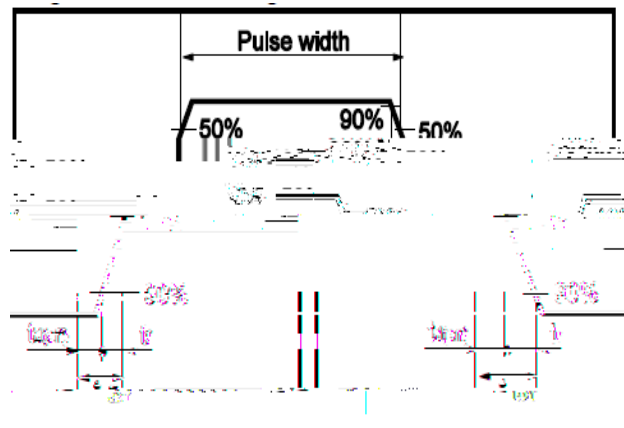

Fig.11 Avalanche Measurement Circuit

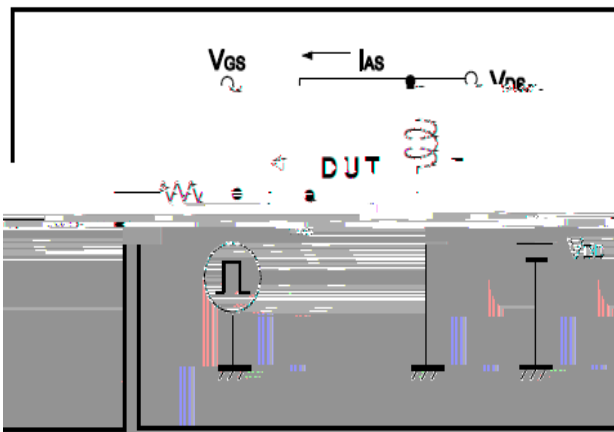
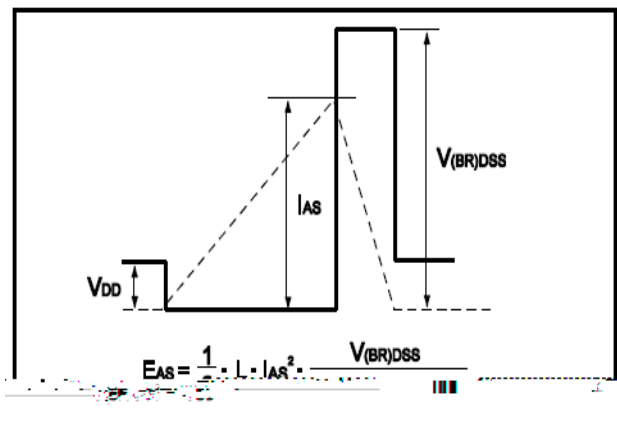

Fig.12 Avalanche Waveform



Dimensions(SOP8)

Unit: mm

SYMBOL	min	TYP	max	SYMBOL	min		max
A	4.80		5.25	C	1.30		1.75
A1	0.37		0.49	C1	0.55		0.75
A2		1.27		C2	0.55		0.65
A3		0.41		C3	0.05		0.20
B	5.80		6.20	C4	0.10	0.20	0.23
B1	3.80		4.10	D		1.05	
B2		5.00		D1	0.40		0.62

