

---

Avalanche Current	$I_{AS}$ $I_{AR}$	40	A
-------------------	-------------------	----	---

**Thermal resistance**

Parameter	Symbol	Min.	Typ.	Max.	Unit
Thermal resistance, junction - case	$R_{thJC}$	-	-	2.5	$^{\circ}$ C/W
Thermal resistance, junction - ambient	$R_{thJA}$	-	-	70	$^{\circ}$ C/W
Soldering temperature, wavesoldering for 10s	$T_{sold}$	-	-	265	$^{\circ}$ C

**Electronic Characteristics**

Parameter	Symbol	Condition	Min.	Typ	Max.	Unit
Drain-Source Breakdown Voltage	$BV_{DSS}$	$V_{GS} = 0V, I_D = 250\mu A$	30			V
Gate Threshold Voltage	$V_{GS(TH)}$	$V_{GS} = V_{DS}, I_D = 250\mu A$	1.2		2.5	V
Drain-Source Leakage Current	$I_{DSS}$	$V_{DS} = 30V, V_{GS} = 0V$			1.0	$\mu A$
Gate- Source Leakage Current	$I_{GSS}$	$V_{GS} = \pm 20V, V_{DS} = 0V$			100	nA
Static Drain-source On Resistance		$V_{GS} = 10V, I_D = 20A$				
		$V_{GS} = 4.5V, I_D = 10A$				
Forward Transconductance	$g_{FS}$	$V_{DS} = 25V, I_D = 10A$				
Source-drain voltage	$V_{SD}$	$I_S = 10A$				

**Electronic Characteristics**

Parameter	Symbol	Condition	Min.	Typ	Max.	Unit
Input capacitance	$C_{iss}$	$f = 1MHz$	-	1150	-	$\mu F$
Output capacitance	$C_{oss}$		-	230	-	
Reverse transfer capacitance	$C_{rss}$		-	113	-	

**Gate Charge characteristics( $T_a = 25$  )**

Parameter	Symbol	Condition	Min.	Typ	Max.	Unit
Total gate charge	$Q_g$	$V_{DD} = 25V$	-	12	-	nC
Gate - Source charge	$Q_{gs}$	$I_D = 5A$	-	4	-	
Gate - Drain charge	$Q_{gd}$	$V_{GS} = 10V$	-	6	-	

Note:

;

Fig.1 Power Dissipation

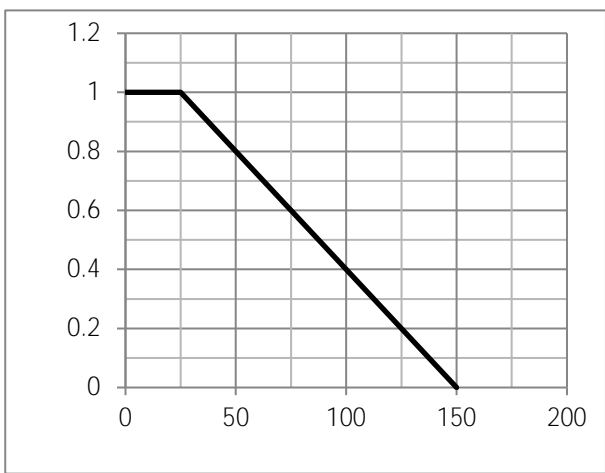

Fig.2 Typical output Characteristics

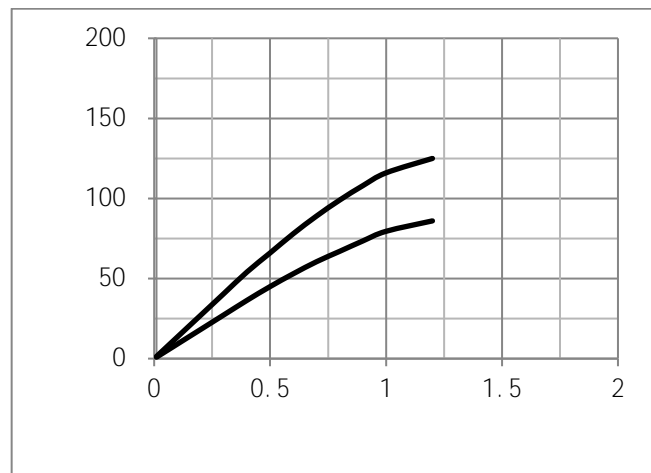

Fig.3 Threshold Voltage V.S Junction Temperature

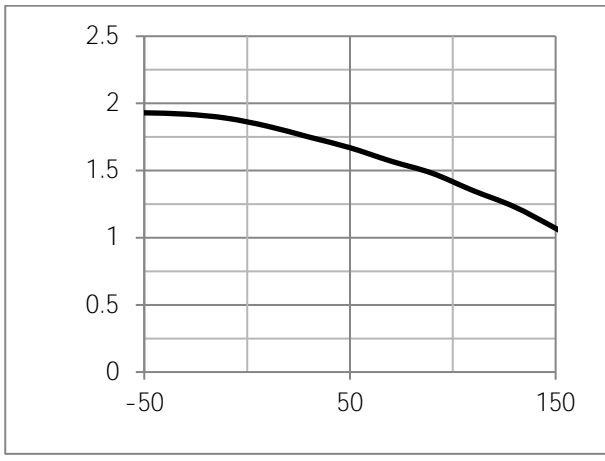

Fig.4 Resistance V.S Drain Current

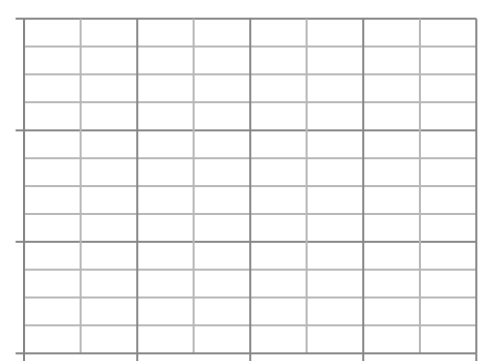
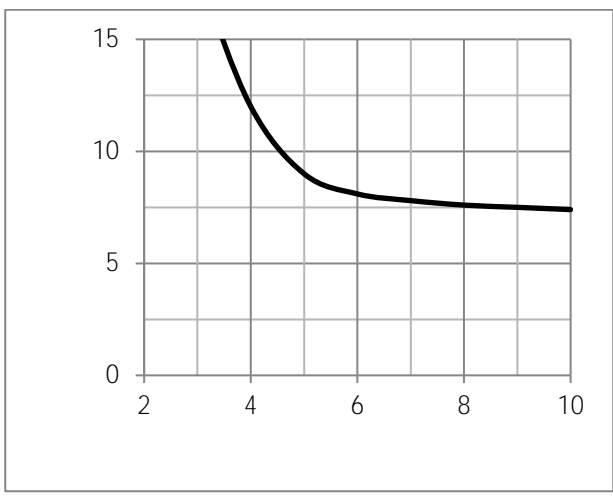
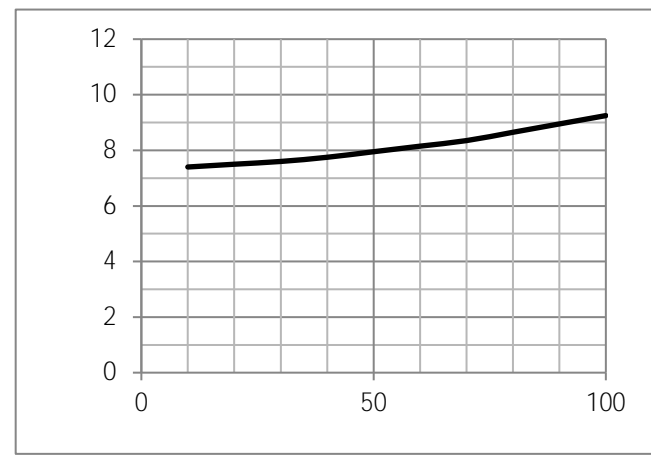

Fig.7 Switching Time Measurement Circuit

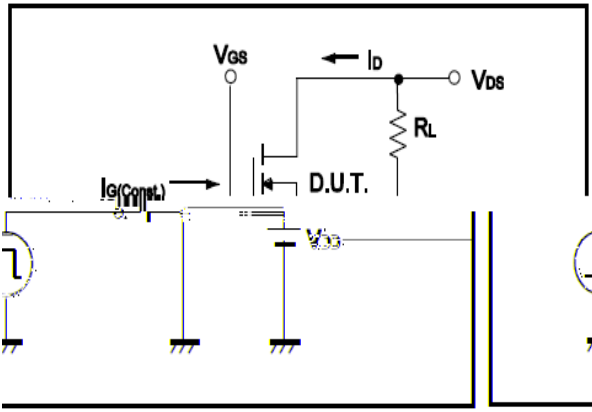

Fig.8 Gate Charge Waveform

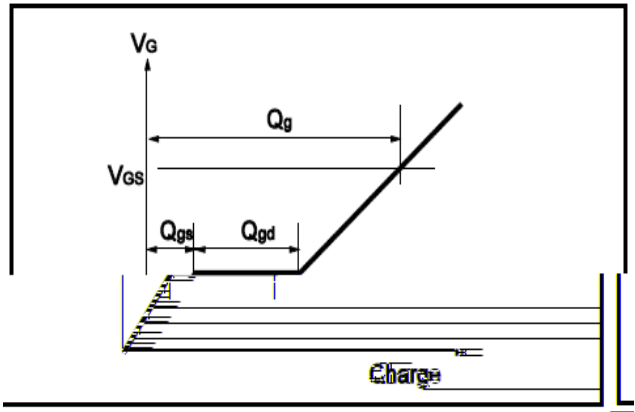

Fig.9 Switching Time Measurement Circuit

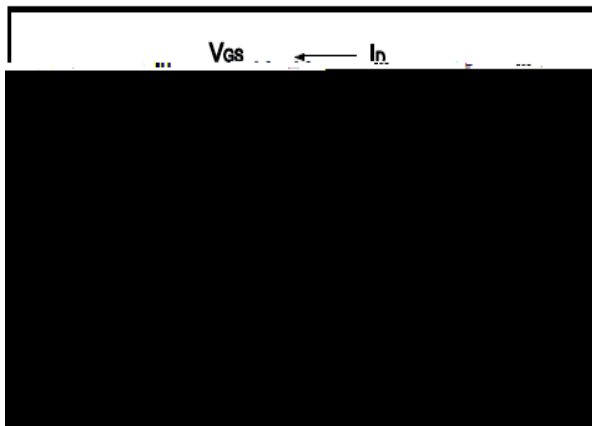

Fig.10 Gate Charge Waveform

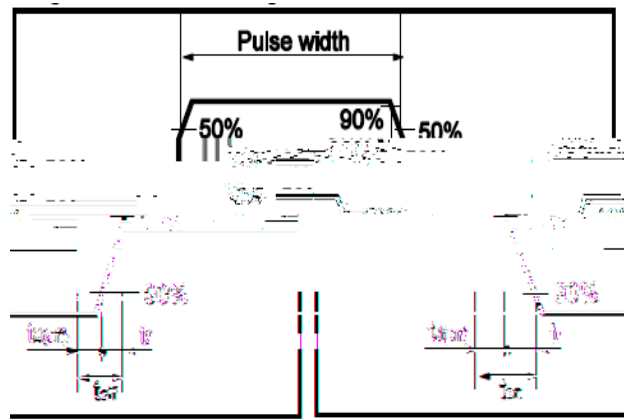

Fig.11 Avalanche Measurement Circuit

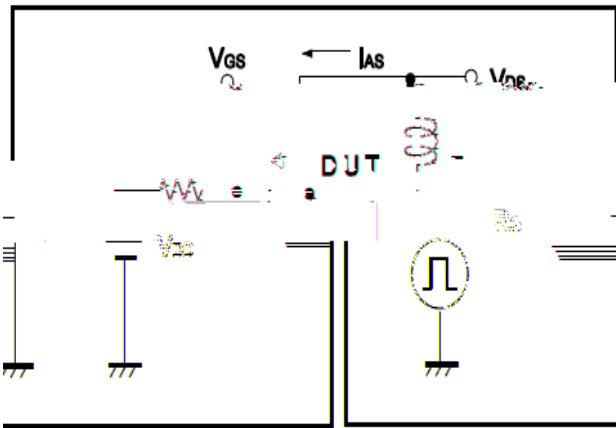
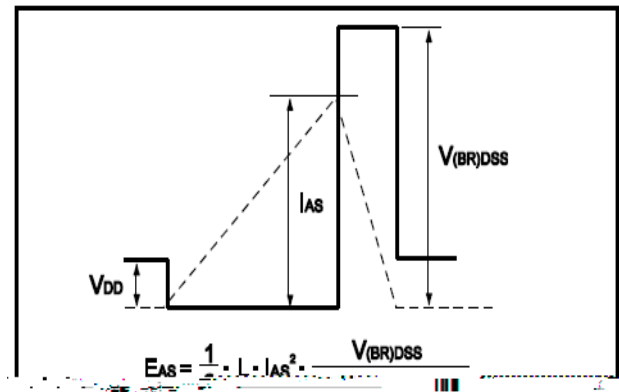

Fig.12 Avalanche Waveform



**Dimensions(SOP8)**

Unit: mm

SYMBOL	min	TYP	max	SYMBOL	min		max
A	4.80		5.25	C	1.30		1.75
A1	0.37		0.49	C1	0.55		0.75
A2		1.27		C2	0.55		0.65
A3		0.41		C3	0.05		0.20
B	5.80		6.20	C4	0.10	0.20	0.23
B1	3.80		4.10	D		1.05	
B2		5.00		D1	0.40		0.62

