

General Description

It combines advanced trench MOSFET technology with a low resistance package to provide extremely low $R_{DS(ON)}$.

Features

Trench technology
 $R_{DS(ON)}$ to minimize conductive loss

Dual DIE in one package

Application

Power Management in Notebook Computer,
 Portable Equipment and Battery Powered
 Systems

Ordering Information:

Absolute Maximum Ratings ($T_C = 25^\circ\text{C}$)

Parameter	Symbol	Rating	Unit
Drain-Source Voltage	V_{DS}	40	V
Gate-Source Voltage	V_{GS}	± 20	V
Continuous Drain Current	$I_{D@TC=25}$	12	A
	$I_{D@TC=75}$	9	A
	$I_{D@TC=100}$	7.5	A
Pulsed Drain Current	I_{DM}	36	A
Total Power Dissipation	$P_D@TC=25$	11	W
Total Power Dissipation	$P_D@TA=25$	2.1	W
Operating Junction Temperature	T_J	-55 to 150	
Storage Temperature	T_{STG}	-55 to 150	
Single Pulse Avalanche Energy	E_{AS}	65	mJ

Thermal resistance

Parameter	Symbol	Min.	Typ.	Max.	Unit
Thermal resistance, junction - case	R_{thJC}	-	-	11	° C/W
Thermal resistance, junction - ambient	R_{thJA}	-	-	60	° C/W
Soldering temperature, wavesoldering for 10s	T_{sold}	-	-	265	° C

Electronic Characteristics

Parameter	Symbol	Condition	Min.	Typ	Max.	Unit
Drain-Source Breakdown Voltage	BV_{DSS}	$V_{GS} = 0V, I_D = 250\mu A$	40			V
Gate Threshold Voltage	$V_{GS(TH)}$	$V_{GS} = V_{DS}, I_D = 250\mu A$	1.2	1.8	2.5	V
Drain-Source Leakage Current	I_{DSS}	$V_{DS} = 40V, V_{GS} = 0V$			1.0	μA
Gate- Source Leakage Current	I_{GSS}	$V_{GS} = \pm 20V, V_{DS} = 0V$				

Fig.1 Power Dissipation

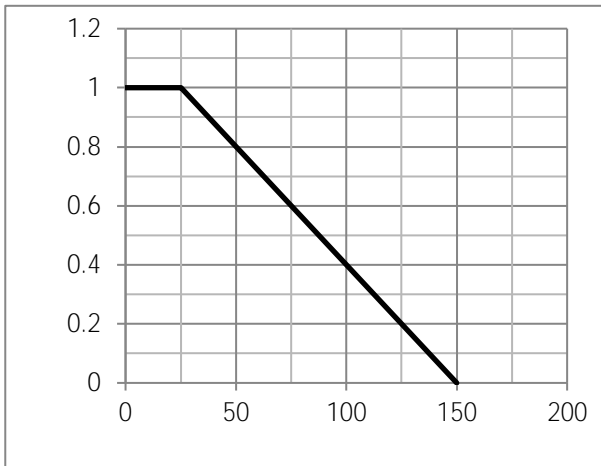

Fig.2 Typical output Characteristics

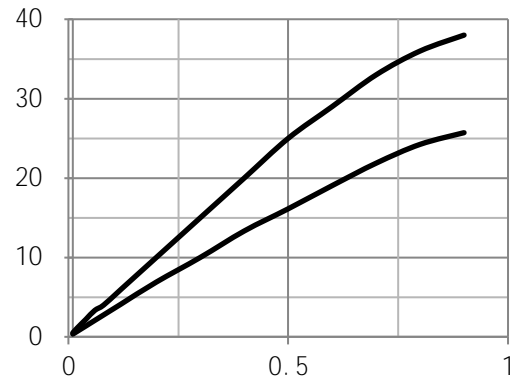

Fig.3 Threshold Voltage V.S Junction Temperature

Fig.4 Resistance V.S Drain Current

Fig.5 On-Resistance VS Gate Source Voltage

Fig.6 On-Resistance V.S Junction Temperature

Fig.7 Switching Time Measurement Circuit

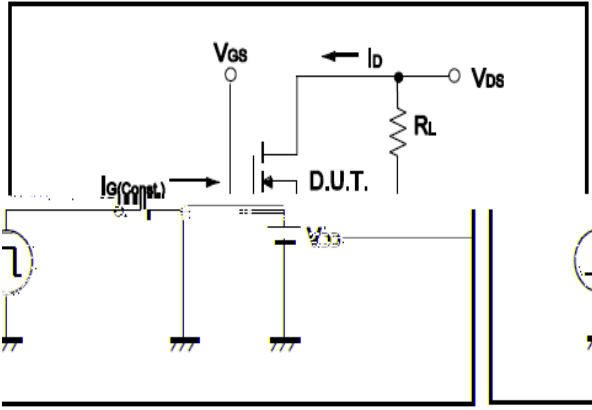

Fig.8 Gate Charge Waveform

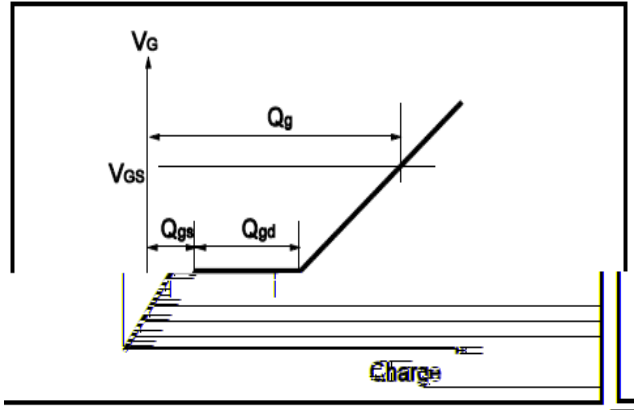

Fig.9 Switching Time Measurement Circuit

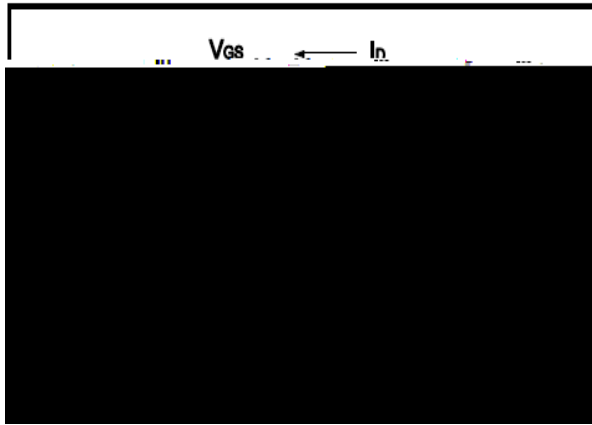

Fig.10 Gate Charge Waveform

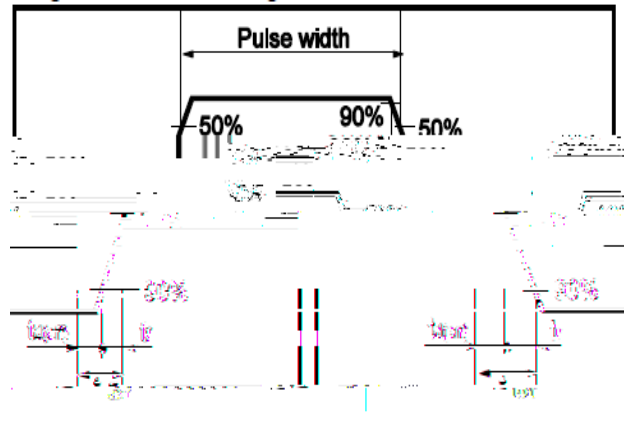

Fig.11 Avalanche Measurement Circuit

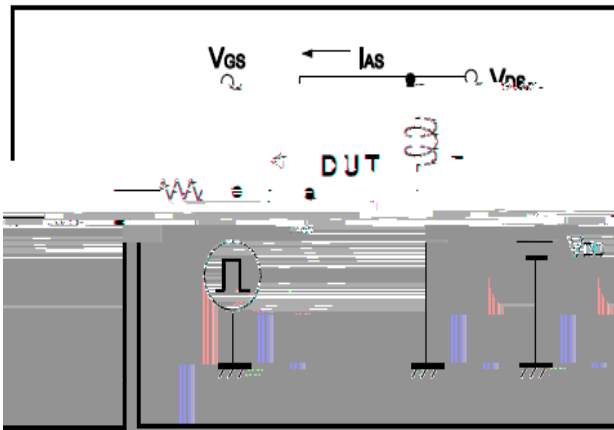

Fig.12 Avalanche Waveform

