

Product Summary

The ZM062N03M combines advanced trench MOSFET technology with a low resistance package to provide extremely low $R_{DS(ON)}$. This device is ideal for load switch and battery protection applications.

Advance high cell density Trench technology
 $R_{DS(ON)}$ to minimize conductive loss

nd Synchronous Rectifier

$T_C = 25$

Parameter	Symbol	Rating	Unit
Drain-Source Voltage	V_{DS}	30	V
Gate-Source Voltage	V_{GS}	± 20	V
Continuous Drain Current	$I_{D@T_C=25}$	40	A
	$I_{D@T_C=75}$	30.4	A
	$I_{D@T_C=100}$	25.2	A
	$I_{D@T_A=25}$	12.9	A
	$I_{D@T_A=70}$	10.4	A
Pulsed Drain Current	I_{DM}	100	A
Total Power Dissipation	$P_D@T_C=25$	43	W
Total Power Dissipation	$P_D@T_A=25$	2.3	W
Operating Junction Temperature	T_J	-55 to 150	
Storage Temperature	T_{STG}	-55 to 150	

Single Pulse Avalanche Energy	E_{AS}	210	mJ
-------------------------------	----------	-----	----

Thermal resistance

Parameter	Symbol	Min.	Typ.	Max.	Unit
Thermal resistance, junction - case	R_{thJC}	-	-	2.9	$^{\circ}C/W$
Thermal resistance, junction - ambient	R_{thJA}	-	-	54	$^{\circ}C/W$
Soldering temperature, wavesoldering for 10s	T_{sold}	-	-	265	$^{\circ}C$

Characteristics

Parameter	Symbol	Condition	Min.	Typ	Max.	Unit
Drain-Source Breakdown Voltage	BV_{DSS}	$V_{GS} = 0V, I_D = 250\mu A$	30			V
Gate Threshold Voltage	$V_{GS(TH)}$	$V_{GS} = V_{DS}, I_D = 250\mu A$	1.2		2.5	V
Drain-Source Leakage Current	I_{DSS}	$V_{DS} = 30V, V_{GS} = 0V$			1.0	μA
Gate- Source Leakage Current	I_{GSS}	$V_{GS} = \pm 20V, V_{DS} = 0V$			100	nA
Static Drain-source On Resistance		$V_{GS} = 10V, I_D = 20A$				
		$V_{GS} = 4.5V, I_D = 10A$				
Forward Transconductance	g_{FS}	$V_{DS} = 25V, I_D = 10A$				
Source-drain voltage	V_{SD}	$I_S = 20A$				

Parameter	Symbol	Condition	Min.	Typ	Max.	Unit
Input capacitance	C_{iss}	$f = 1MHz$	-	1150	-	μF
Output capacitance	C_{oss}		-	235	-	
Reverse transfer capacitance	C_{rss}		-	120	-	

Gate Charge characteristics($T_a = 25^{\circ}C$)

Parameter	Symbol	Condition	Min.	Typ	Max.	Unit
Gate Resistance	R_g	$f = 1MHz, V_{DS} = 25V$		1.8		
Total gate charge	Q_g	$V_{DD} = 25V$ $I_D = 5A$ $V_{GS} = 10V$	-	12	-	nC
Gate - Source charge	Q_{gs}		-	4	-	
Gate - Drain charge	Q_{gd}		-	6	-	



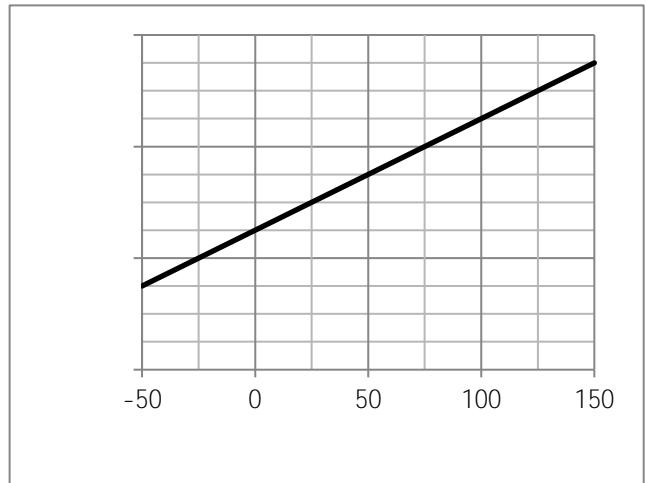
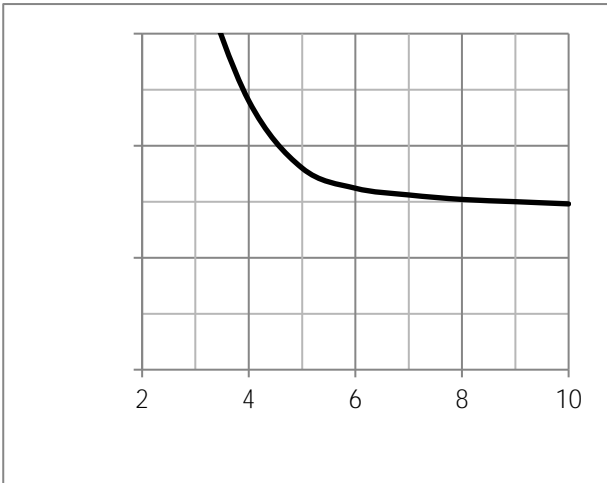

Fig.7 SOA Maximum Safe Operating Area

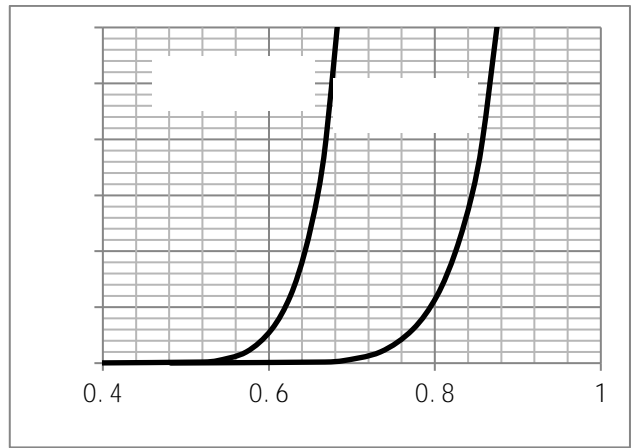
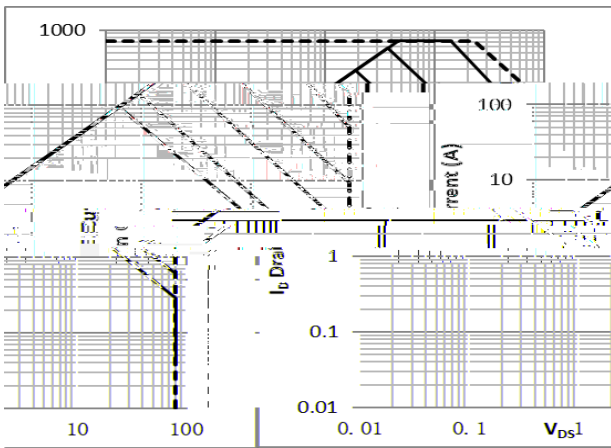
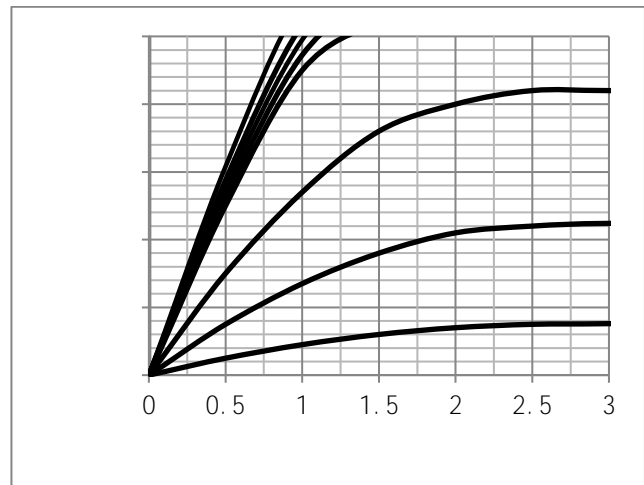
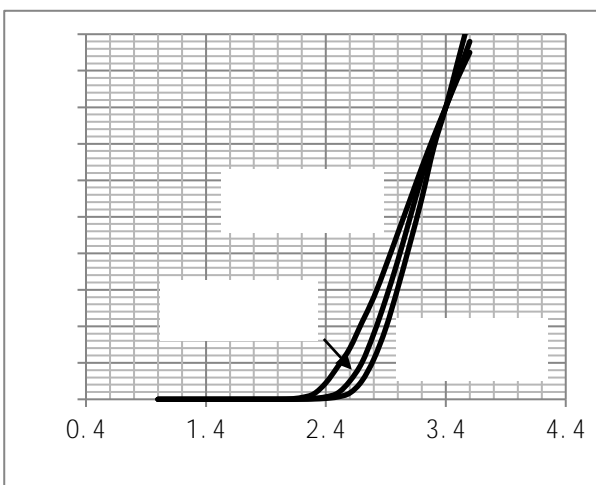

Fig.10 Typical output Characteristics



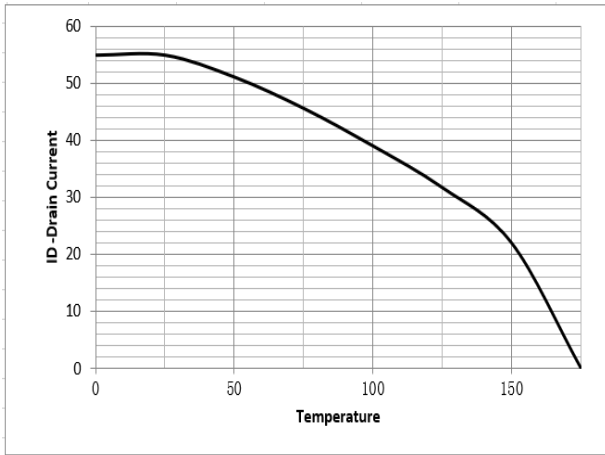

Fig.12 Switching Time Measurement Circuit

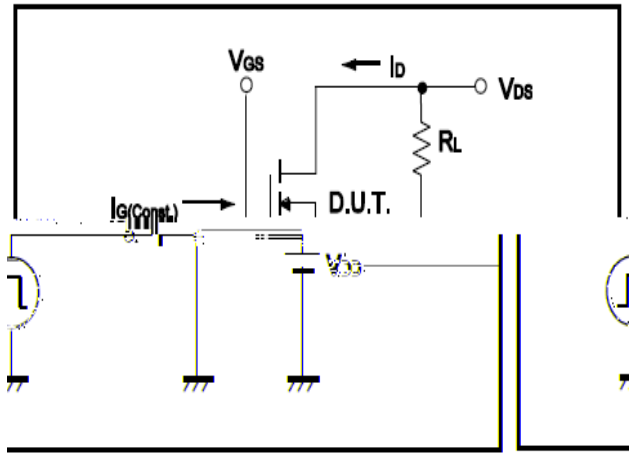

Fig.13 Gate Charge Waveform

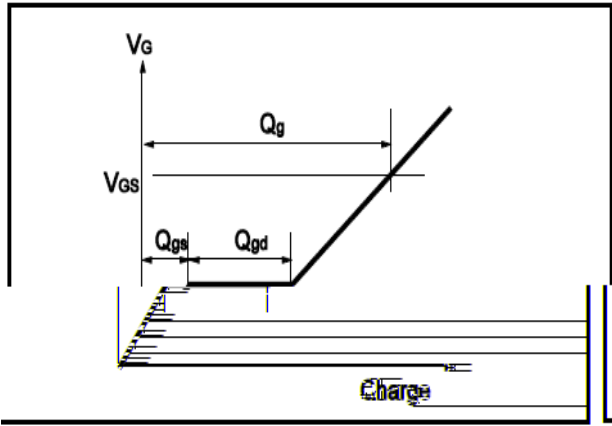

Fig.14 Avalanche Waveform

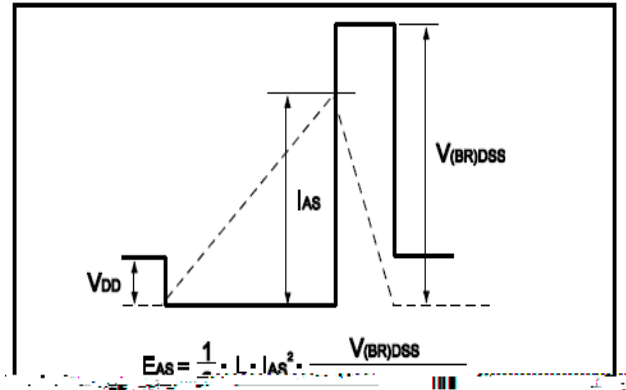

Fig.15 Resistive Switching Test Circuit

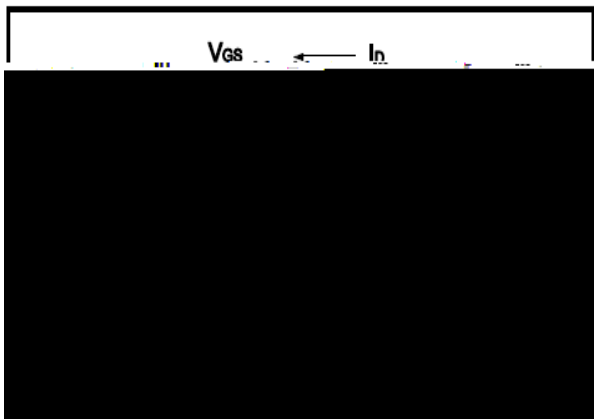

Fig.16 Resistive Switching Test Waveform

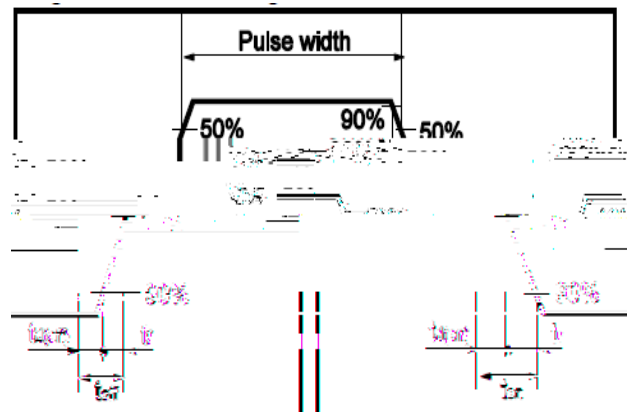

Fig.17 Avalanche Measurement Circuit

