

General Description

The ZMC88305S combines advanced trench MOSFET technology with a low resistance package to provide extremely low $R_{DS(ON)}$. It combine one N Channel MOSFET and one P channel MOSFET.

Features

density Trench technology
 $R_{DS(ON)}$ to minimize conductive loss

Dual DIE in one package

Application

Power Management in Notebook Computer
 BLDC Motor driver

Ordering Information:

	ZMC88305S
	ZMC88305
	REEL TAPE
	4000

N Channel Absolute Maximum Ratings $T_c = 25$

Parameter	Symbol	Rating	Unit
Drain-Source Voltage	V_{DS}	30	V
Gate-Source Voltage	V_{GS}	20	V
Continuous Drain Current	$I_{D@T_C=25}$	7	A
	$I_{D@T_C=75}$	5.3	A
	$I_{D@T_C=100}$	4.4	A
Pulsed Drain Current	I_{DM}	16	A
Total Power Dissipation	$P_D@T_C=25$	2.2	W
Total Power Dissipation	$P_D@T_A=25$	0.69	W
Operating Junction Temperature	T_J	-55 to 150	
Storage Temperature	T_{STG}	-55 to 150	
Single Pulse Avalanche Energy	E_{AS}	6	mJ

Product Summary

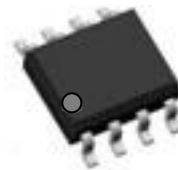
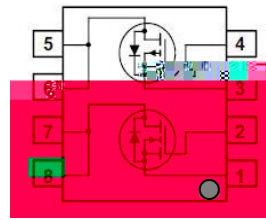

Input capacitance	Ciss	f = 1MHz	-	300	-	pF
Output capacitance	Coss		-	55	-	
Reverse transfer capacitance	Crss		-	50	-	

Gate Charge characteristics(T_a = 25)

Parameter	Symbol	Condition	Min.	Typ	Max.	Unit
Total gate charge	Qg	V _{DD} =25V	-	6	-	nC
Gate - Source charge	Qgs	I _D = 6A	-	1	-	
Gate - Drain charge	Qgd	V _{GS} = 10V	-	1.5	-	

P Channel Electronic Characteristics

Parameter	Symbol	Condition	Min.	Typ	Max.	Unit
Drain-Source Breakdown Voltage	BV _{DSS}	V _{GS} =0V, I _D =-250uA	-30			V
Gate Threshold Voltage	V _{GS(TH)}	V _{GS} =V _{DS} , I _D =-250uA	-1.2		-2.5	V
Drain-Source Leakage Current	I _{DSS}	V _{DS} =-30V, V _{GS} =0V			-1.0	uA
Gate- Source Leakage Current	I _{GSS}	V _{GS} =±20V, V _{DS} =0V			100	nA
Static Drain-source On Resistance		V _{GS} =-10V, I _D =-6A				
		V _{GS} =-4.5V, I _D =-4A				
Forward Transconductance	g _{FS}	V _{DS} =-10V, I _D =-5A				

Electronic Characteristics

Parameter	Symbol	Condition	Min.	Typ	Max.	Unit
Input capacitance	Ciss	f = 1MHz	-	430	-	pF
Output capacitance	Coss		-	140	-	
Reverse transfer capacitance	Crss		-	90	-	

Gate Charge characteristics(T_a = 25)

Parameter	Symbol	Condition	Min.	Typ	Max.	Unit
Total gate charge	Qg	V _{DD} = -25V	-	11	-	nC
Gate - Source charge	Qgs	I _D = -8A	-	2.0	-	
Gate - Drain charge	Qgd	V _{GS} = -10V	-	2.9	-	

N Channel characteristics curve

Fig.1 Power Dissipation

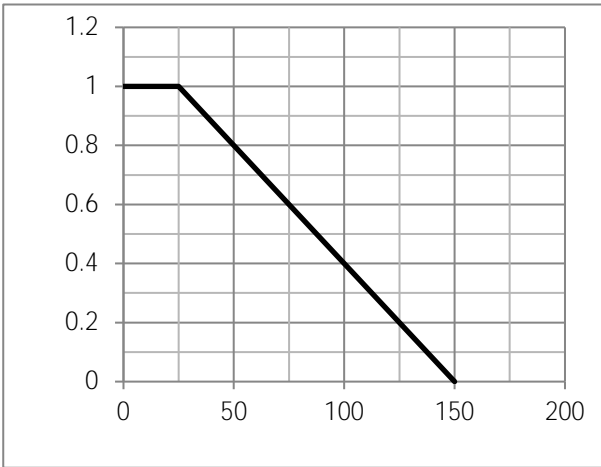

Fig.2 Typical output Characteristics

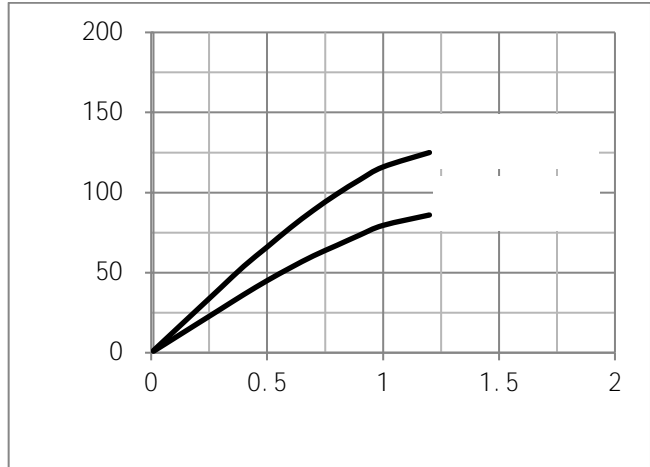

Fig.3 Threshold Voltage V.S Junction Temperature

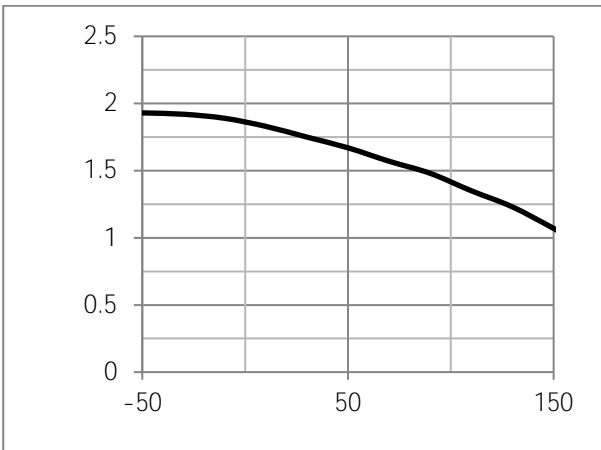
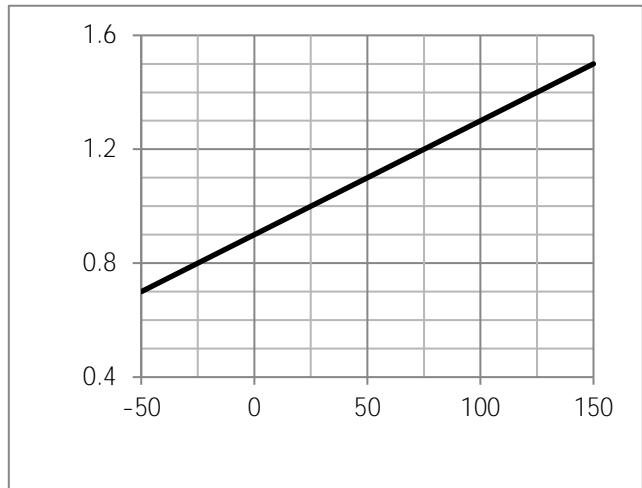
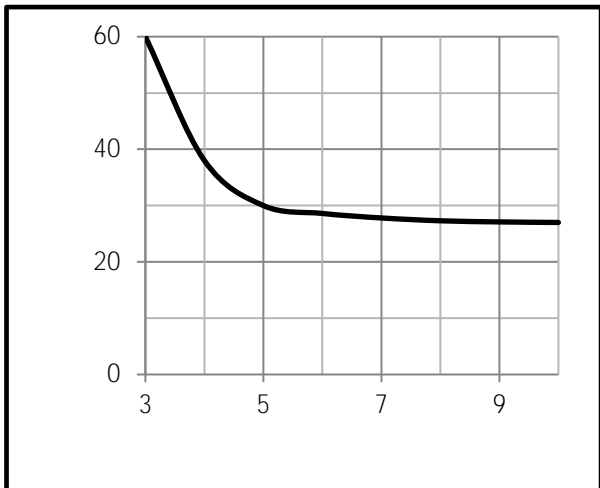
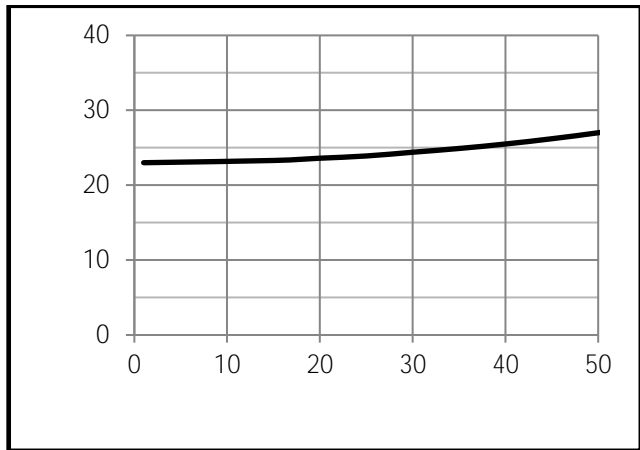

Fig.4 Resistance V.S Drain Current



P Channel characteristics curve

Fig.1 Power Dissipation Derating Curve

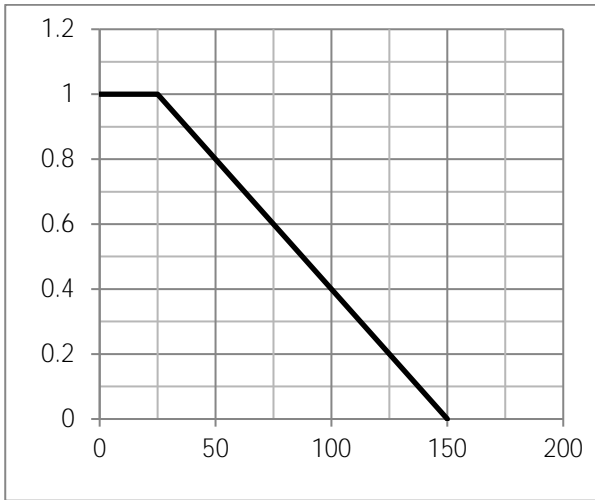

Fig.2 Typical output Characteristics

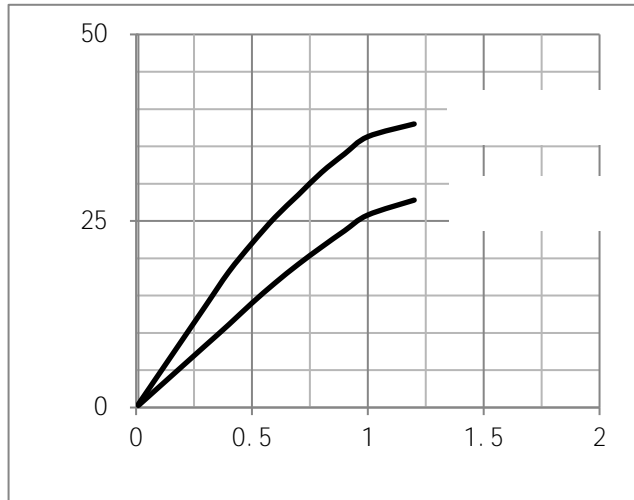

Fig.3 Threshold Voltage V.S Junction Temperature

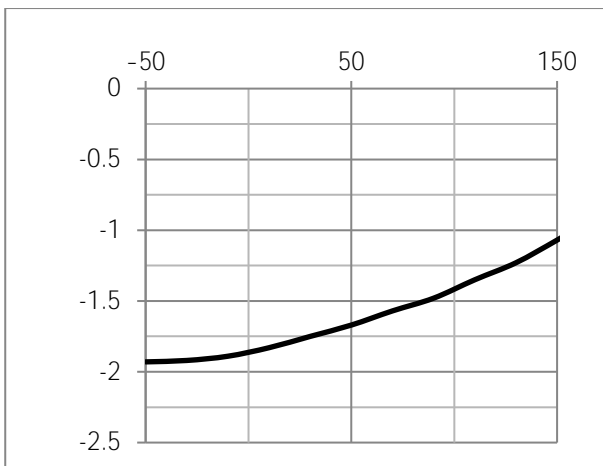
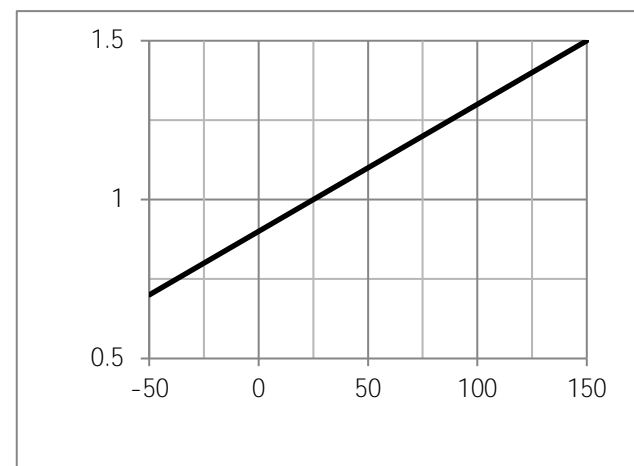
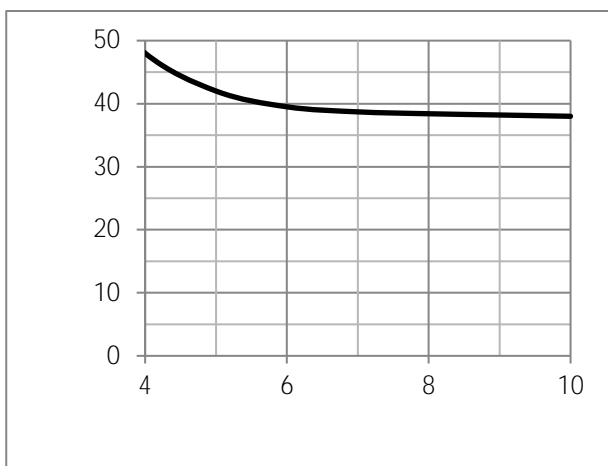
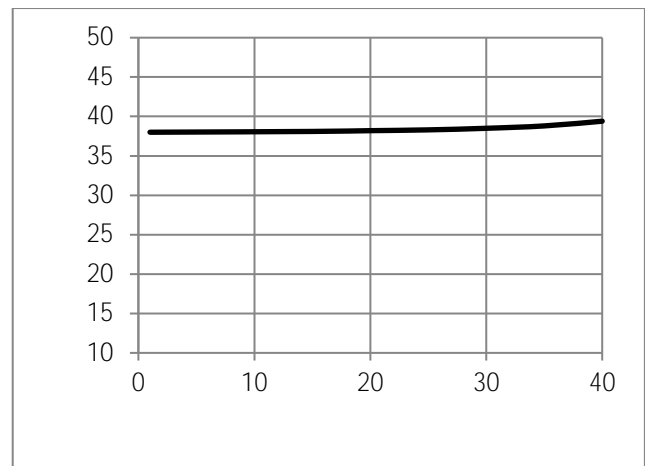

Fig.4 Resistance V.S Drain Current



Test Circuit

Fig.1 Switching Time Measurement Circuit

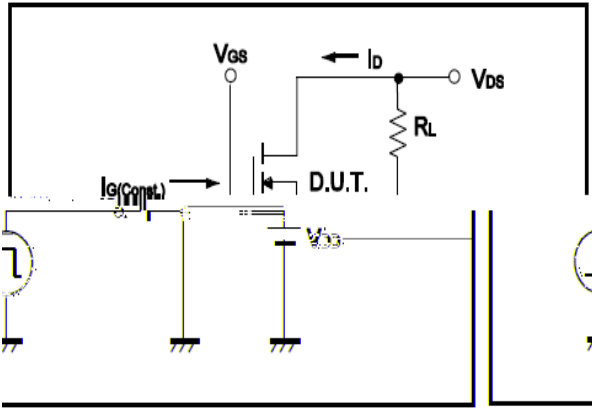

Fig.2 Gate Charge Waveform

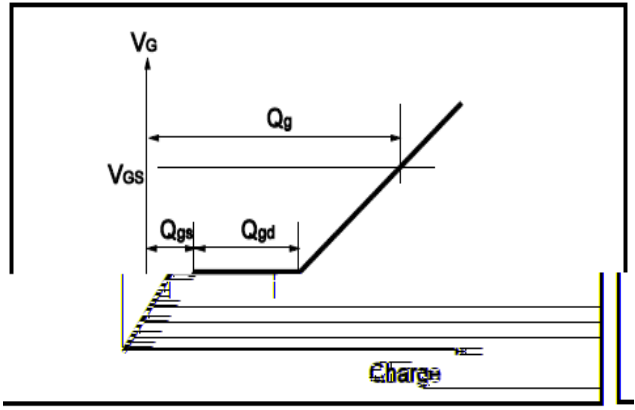

Fig.3 Switching Time Measurement Circuit

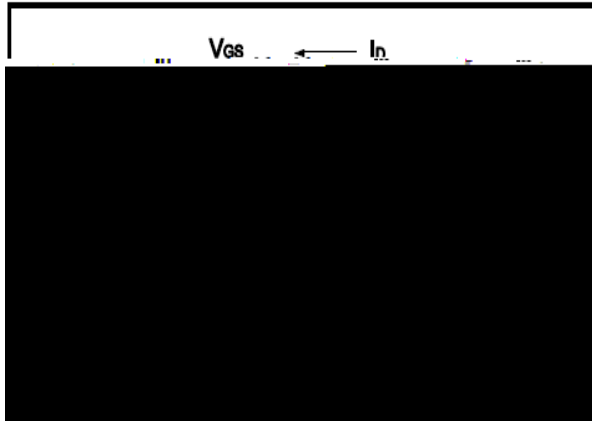

Fig.4 Gate Charge Waveform

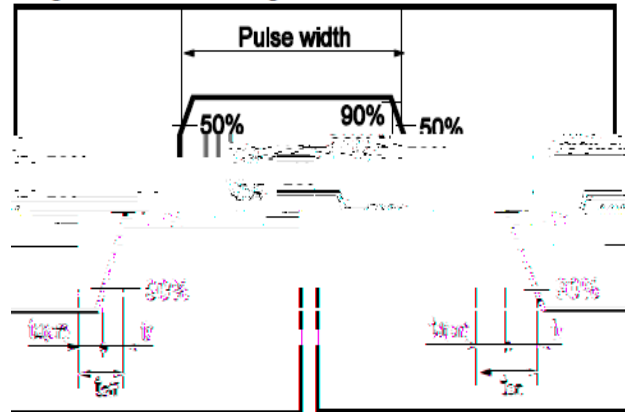

Fig.5 Avalanche Measurement Circuit

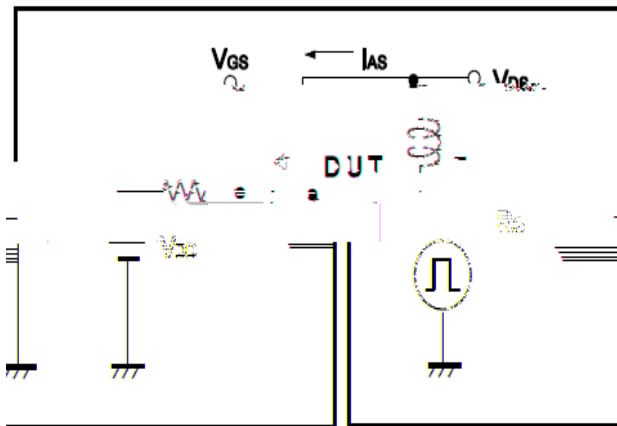
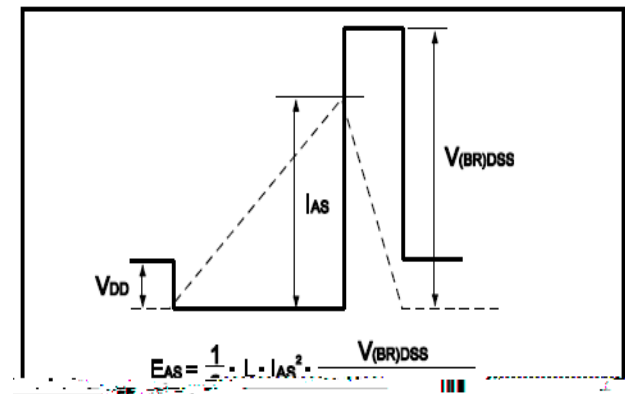

Fig.6 Avalanche Waveform



Dimensions(SOP8)

Unit: mm

SYMBOL	min	TYP	max	SYMBOL	min		max
A	4.80		5.25	C	1.30		1.75
A1	0.37		0.49	C1	0.55		0.75
A2		1.27		C2	0.55		0.65
A3		0.41		C3	0.05		0.20
B	5.80		6.20	C4	0.10	0.20	0.23
B1	3.80		4.10	D		1.05	
B2		5.00		D1	0.40		0.62

