

**B**

The ZM040N04S combines advanced trench MOSFET technology with a low resistance package to provide extremely low  $R_{DS(ON)}$ . This device is ideal for load switch and battery protection applications.

Advance high cell density Trench technology  
 $R_{DS(ON)}$  to minimize conductive loss

nd Synchronous Rectifier

**Product Summary**

$V_{DS} = 40V$

$R_{DS(ON)} = 5.5m\Omega$

$I_D = 15A$

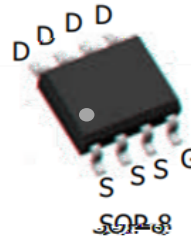
**Information:**

Part NO.	ZM040N04S
Marking	ZM040N04
Packing Information	REEL TAPE
Basic ordering unit (pcs)	4000-TAP

 $T_C = 25$ 

Parameter	Symbol	Rating	Unit
Drain-Source Voltage	$V_{DS}$	40	V
Gate-Source Voltage	$V_{GS}$	$\pm 20$	V
Continuous Drain Current	$I_D @ T_C = 25$	15	A
	$I_D @ T_C = 75$	11	A
	$I_D @ T_C = 100$	9.5	A
Pulsed Drain Current	$I_{DM}$	40	A
Total Power Dissipation	$P_D @ T_C = 25$	4.0	W
Total Power Dissipation	$P_D @ T_A = 25$	0.75	W
Operating Junction Temperature	$T_J$	-55 to 150	
Storage Temperature	$T_{STG}$	-55 to 150	
Single Pulse Avalanche Energy	$E_{AS}$	180	mJ



Fig.1 Power Dissipation

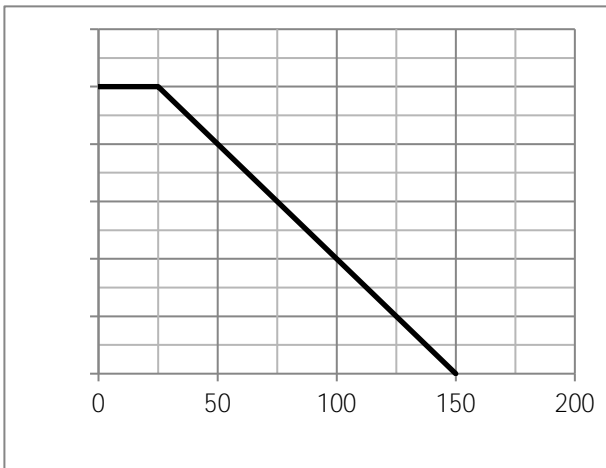

Fig.2 Typical output Characteristics

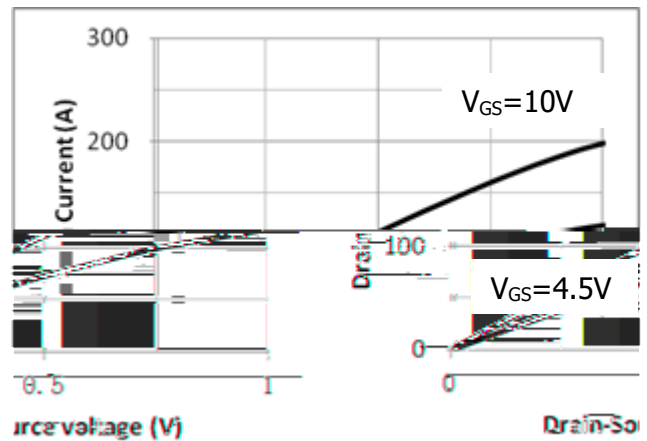

Fig.3 Threshold Voltage V.S Junction Temperature

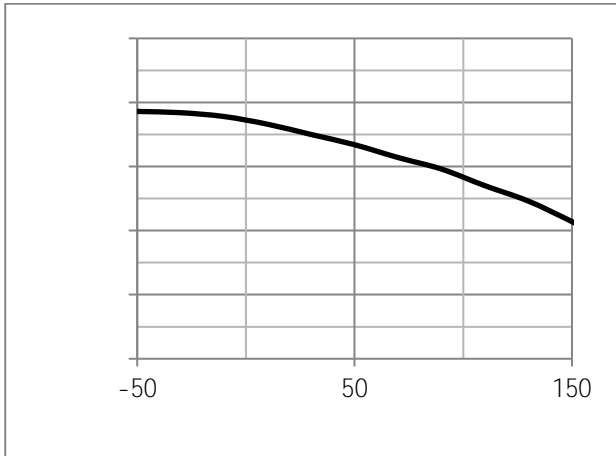

Fig.4 Resistance V.S Drain Current

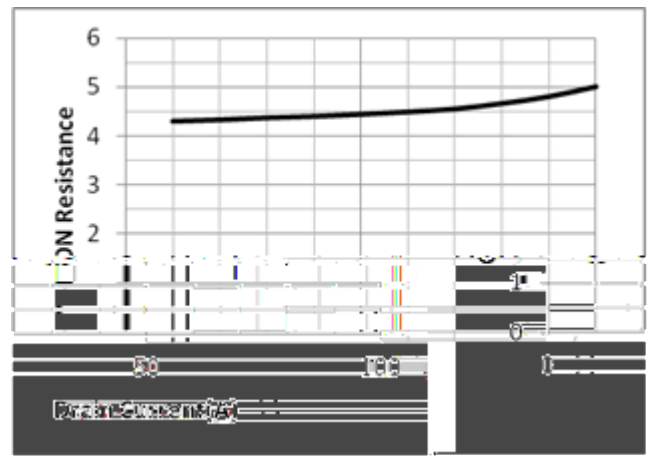

Fig.5 On-Resistance VS Gate Source Voltage

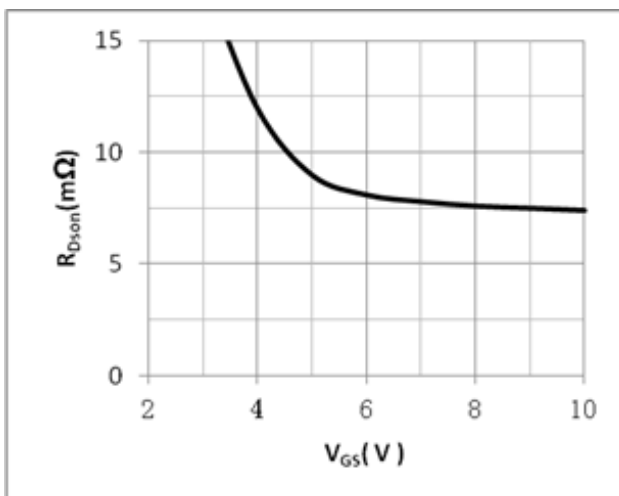

Fig.6 On-Resistance V.S Junction Temperature

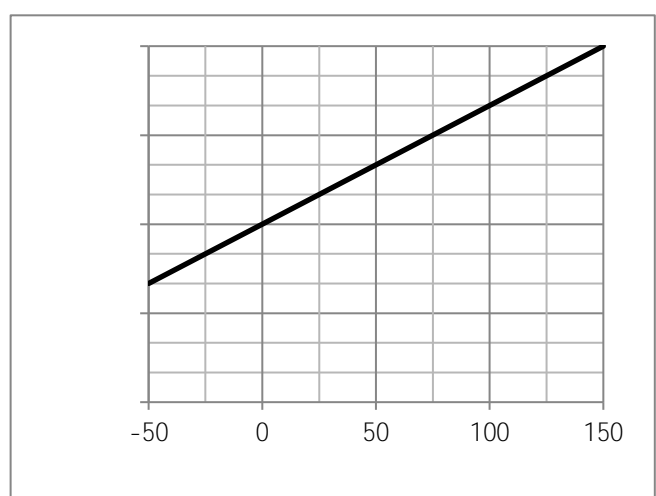

Fig.7 Switching Time Measurement Circuit

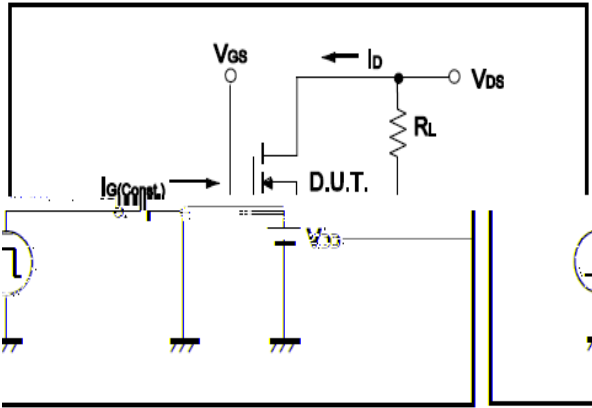

Fig.8 Gate Charge Waveform

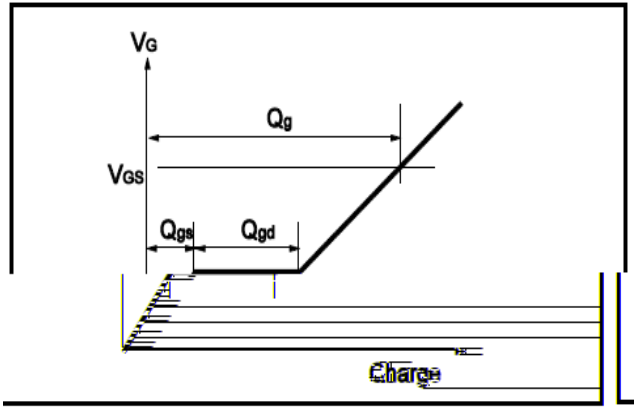

Fig.9 Switching Time Measurement Circuit

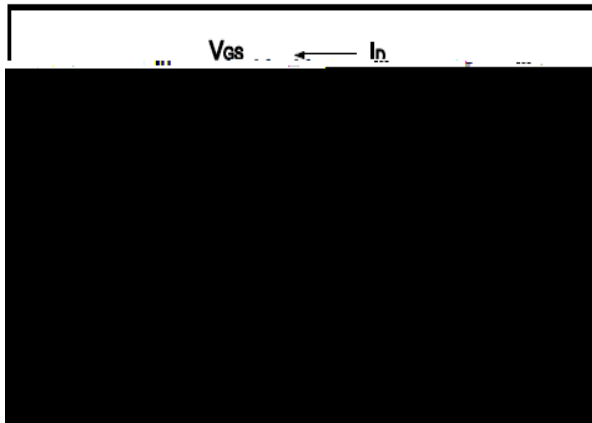

Fig.10 Gate Charge Waveform

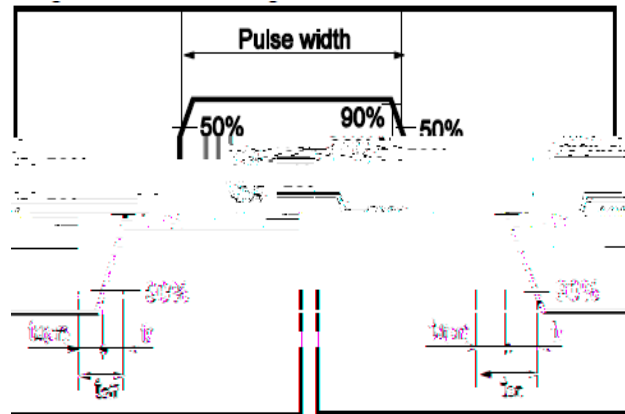

Fig.11 Avalanche Measurement Circuit

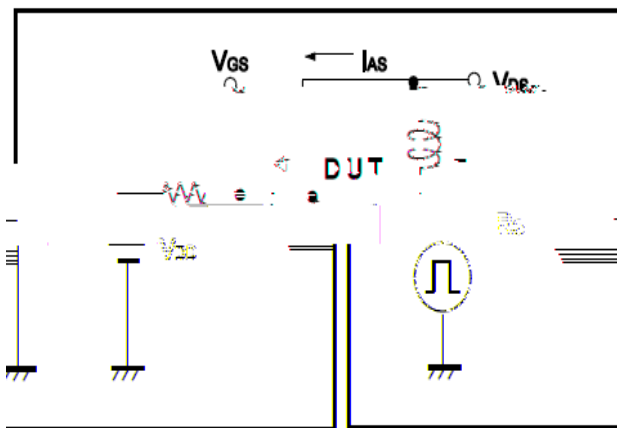
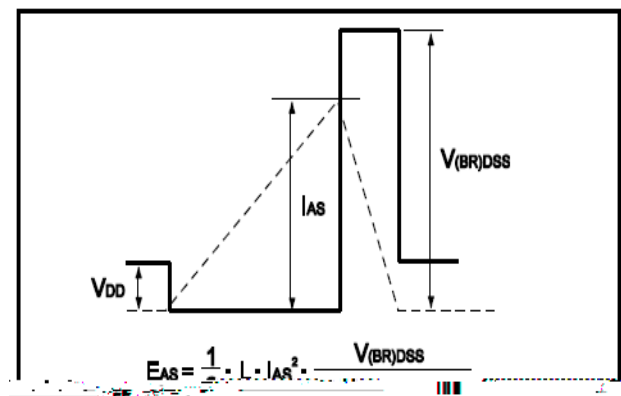

Fig.12 Avalanche Waveform



(SOP8)

Unit: mm

SYMBOL	min	TYP	max	SYMBOL	min		max
A	4.80		5.25	C	1.30		1.75
A1	0.37		0.49	C1	0.55		0.75
A2		1.27		C2	0.55		0.65
A3		0.41		C3	0.05		0.20
B	5.80		6.20	C4	0.10	0.20	0.23
B1	3.80		4.10	D		1.05	
B2		5.00		D1	0.40		0.62

