

B

It combines advanced trench MOSFET technology with a low resistance package to provide extremely low $R_{DS(ON)}$.

device constructure

$R_{DS(ON)}$ to minimize conduction loss

Synchronous Rectification for AC-DC/DC-DC

converter

Oring switches

Power Tools

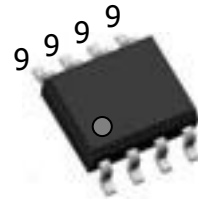
Product Summary

D "

D

Part NO.	ZMS090N06S
Marking	ZMS090N06
Packing Information	REEL TAPE
Basic ordering unit (pcs)	4000

$T_C = 25$

Parameter	Symbol	Rating	Unit
Drain-Source Voltage	V_{DS}	65	V
Gate-Source Voltage	V_{GS}	± 20	V
Continuous Drain Current	$I_D @ T_C = 25$	11	A
	$I_D @ T_C = 75$	9.9	A
	$I_D @ T_C = 100$	8.2	A
Pulsed Drain Current	I_{DM}	34	A
Total Power Dissipation	$P_D @ T_C = 25$	70	W
Total Power Dissipation	$P_D @ T_A = 25$	2.5	W
Operating Junction Temperature	T_J	-55 to 150	
Storage Temperature	T_{STG}	-55 to 150	
Single Pulse Avalanche Energy	E_{AS}	47	mJ



Fig.1 Gate-Charge Characteristics

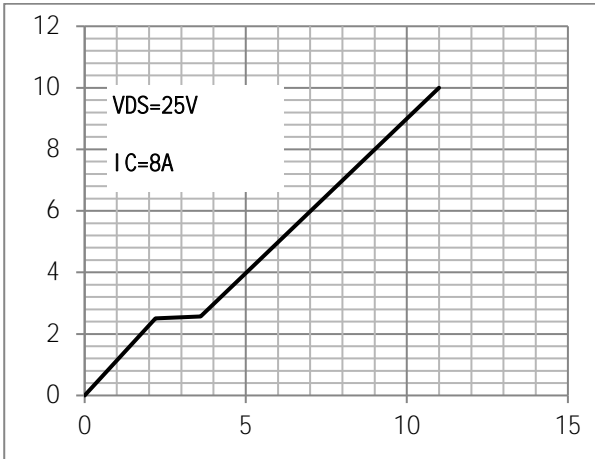

Fig.2 Capacitance Characteristics

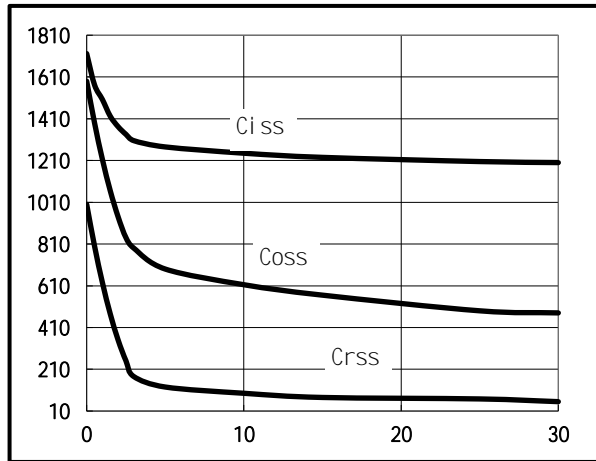

Fig.3 Power Dissipation

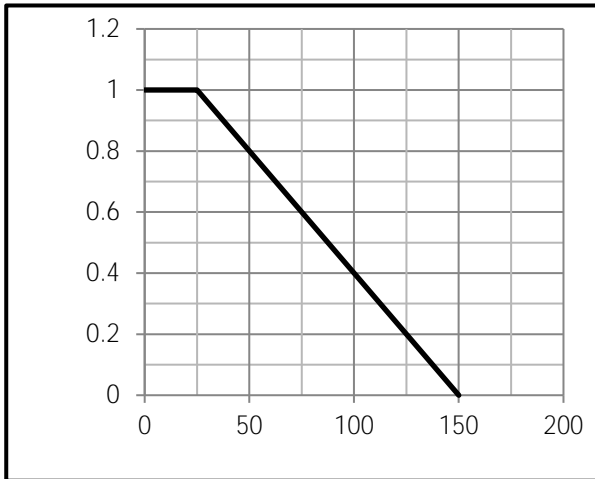

Fig.4 Typical output Characteristics

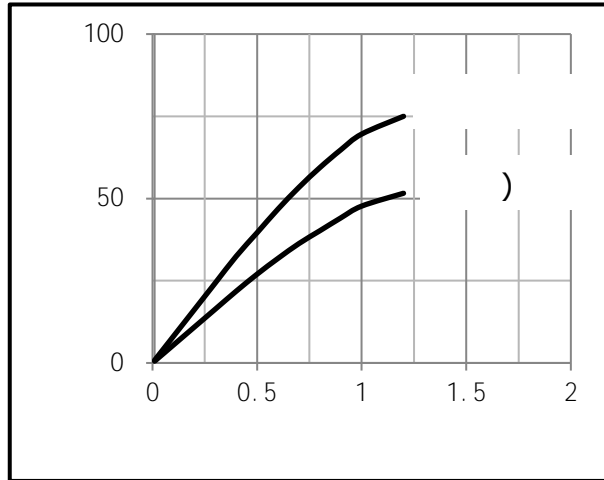

Fig.5 Threshold Voltage V.S Junction Temperature

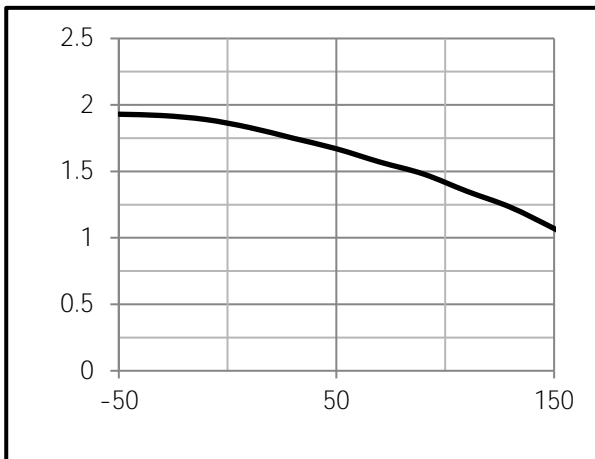
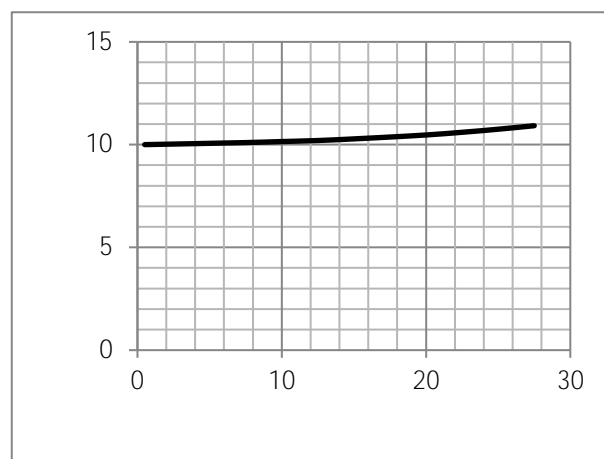

Fig.6 Resistance V.S Drain Current



D "G

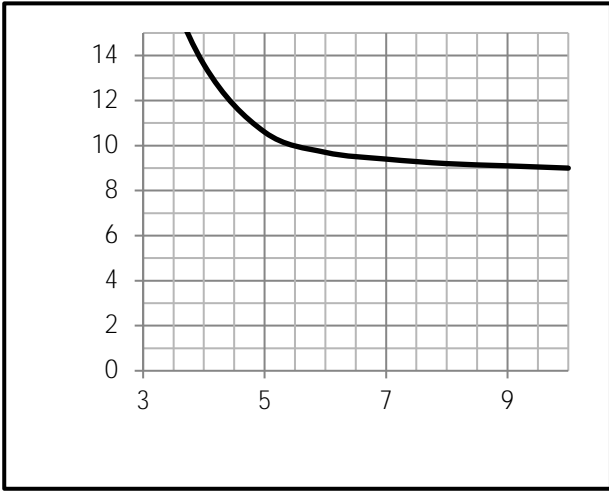

Fig.9 Switching Time Measurement Circuit

- D "G

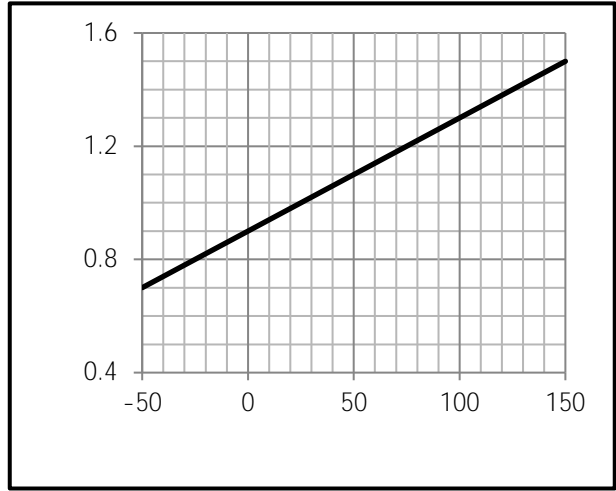

Fig.10 Gate Charge Waveform

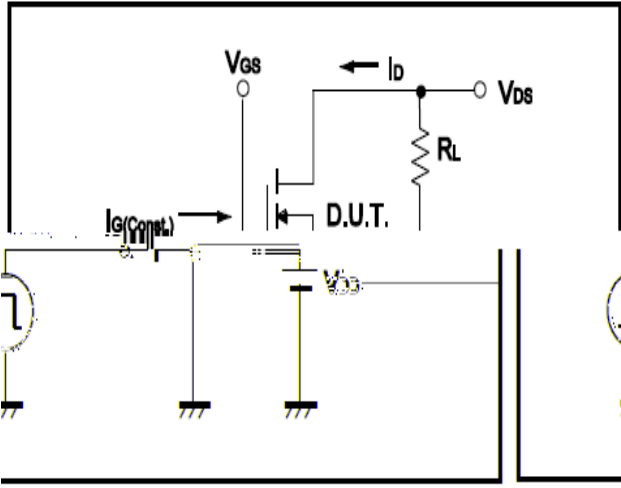

Fig.11 Switching Time Measurement Circuit

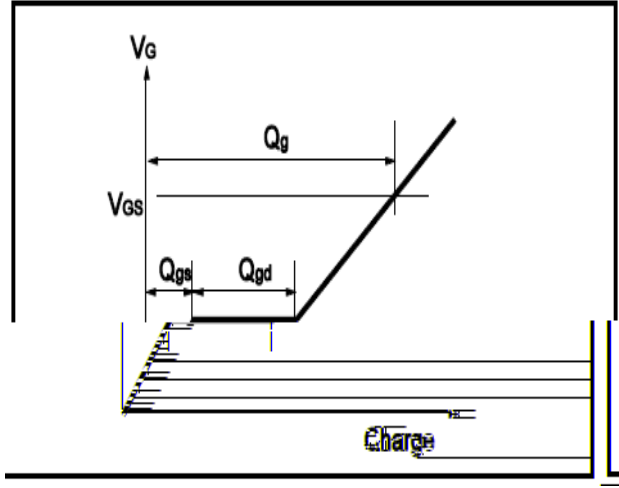
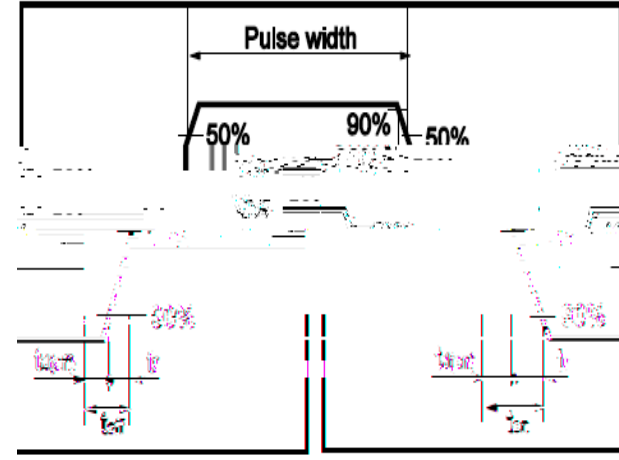
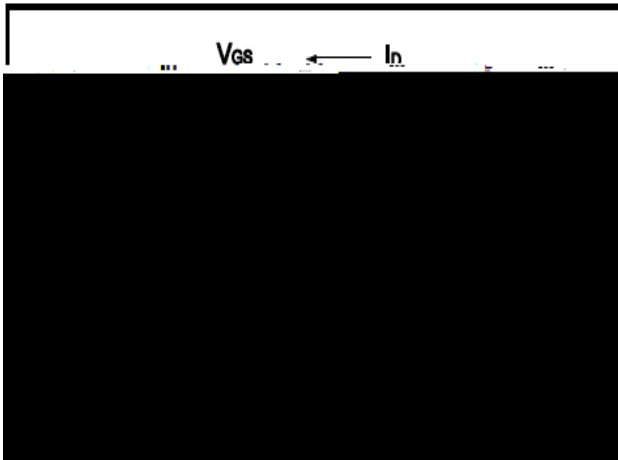

Fig.12 Gate Charge Waveform



(SOP8)

Unit: mm

SYMBOL	min	TYP	max	SYMBOL	min		max
A	4.80		5.25	C	1.30		1.75
A1	0.37		0.49	C1	0.55		0.75
A2		1.27		C2	0.55		0.65
A3		0.41		C3	0.05		0.20
B	5.80		6.20	C4	0.10	0.20	0.23
B1	3.80		4.10	D		1.05	
B2		5.00		D1	0.40		0.62

