



Ordering Information:

Absolute Maximum Ratings $T_C = 25$

| Parameter | Symbol | Rating | Unit |
|----------------------|----------|--------|------|
| Drain-Source Voltage | V_{DS} | 100 | |



Fig.1 Power Dissipation Derating Curve

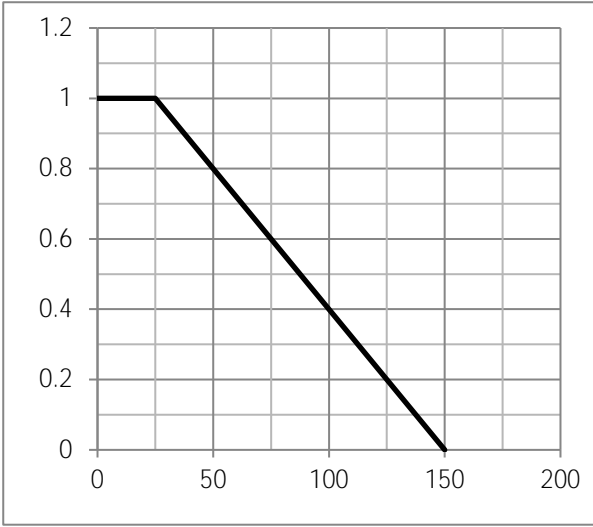

Fig.2 Typical output Characteristics

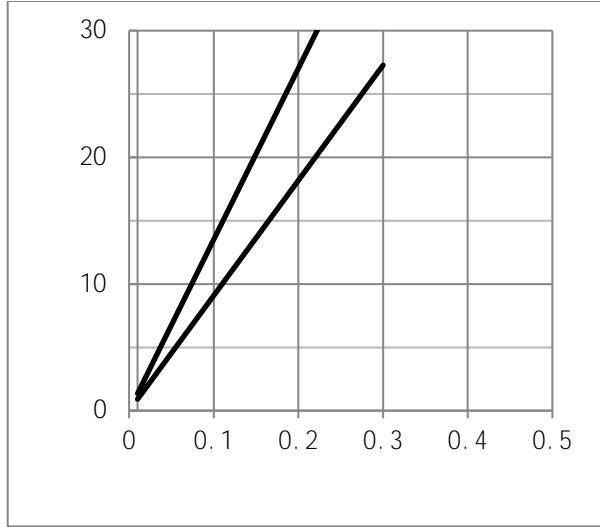

Fig.3 Threshold Voltage V.S Junction Temperature

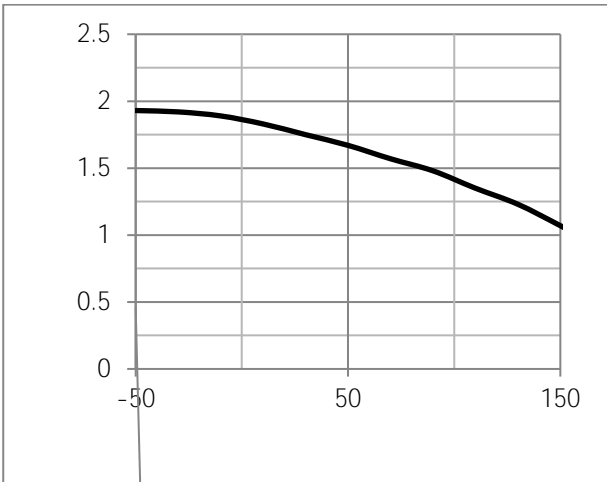
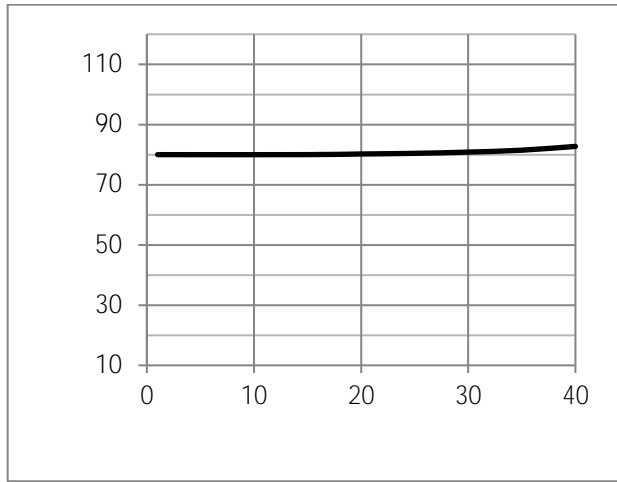
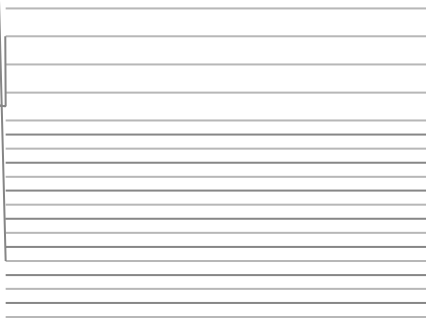

Fig.4 Resistance V.S Drain Current



4



5

-

Fig.7 Switching Time Measurement Circuit

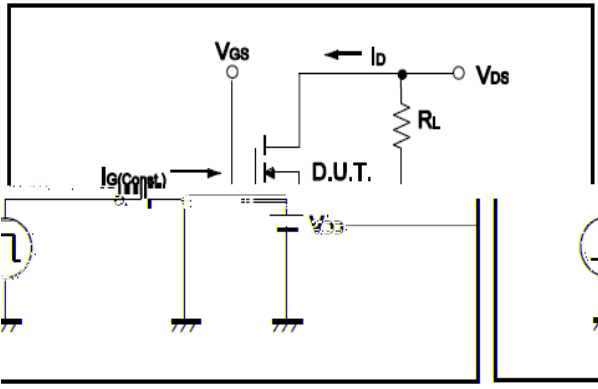

Fig.8 Gate Charge Waveform

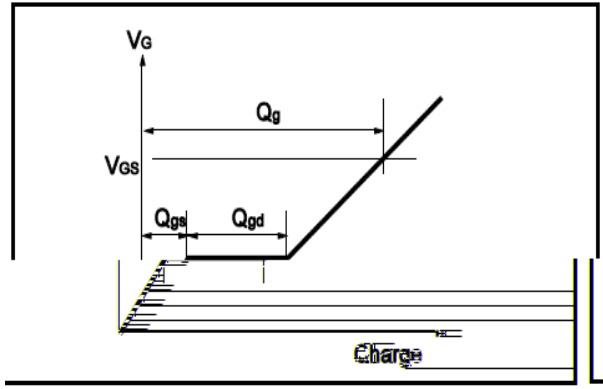

Fig.9 Switching Time Measurement Circuit

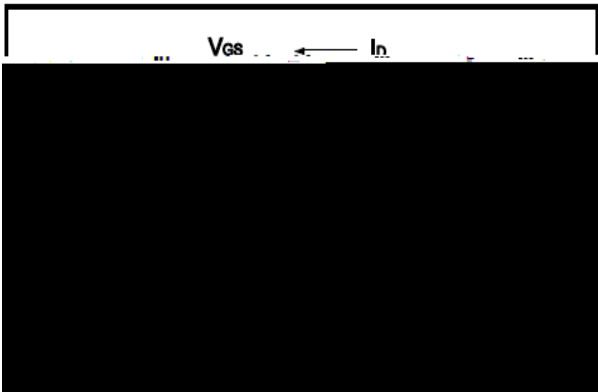

Fig.10 Gate Charge Waveform

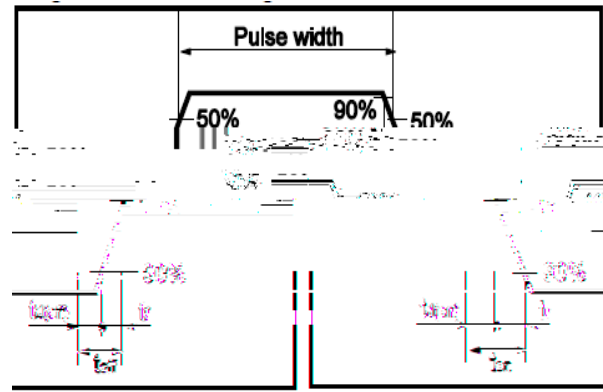

Fig.11 Avalanche Measurement Circuit

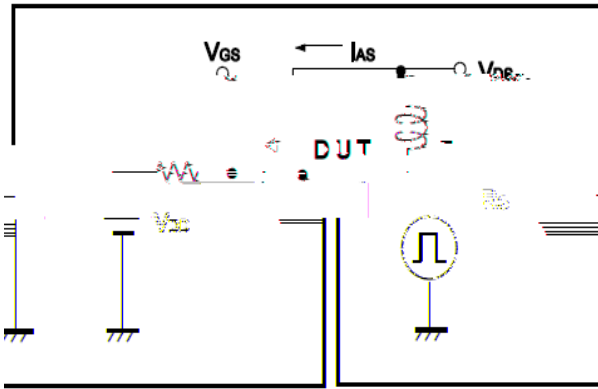

Fig.12 Avalanche Waveform

