

General Description

The ZMC88303S combines advanced trench MOSFET technology with a low resistance package to provide extremely low $R_{DS(ON)}$. It combine one N channel MOSFET and one P channel MOSFET.

Product Summary

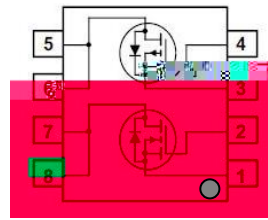

Features

- Trench technology
- $R_{DS(ON)}$ to minimize conductive loss
- Dual DIE in one package

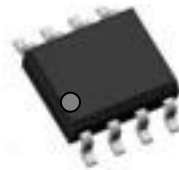

Application

- Power Management in Notebook Computer
- BLDC Motor driver

Ordering Information:

Part NO.	ZMC88303S
Marking	ZMC88303
Packing Information	REEL TAPE
Basic ordering unit (pcs)	4000

N Channel Absolute Maximum Ratings $T_C = 25$

Parameter	Symbol	Rating	Unit
Drain-Source Voltage	V_{DS}	30	V
Gate-Source Voltage	V_{GS}	20	V
Continuous Drain Current	$I_D @ T_C = 25$	9	A
	$I_D @ T_C = 75$	6.84	A
	$I_D @ T_C = 100$	5.67	A
Pulsed Drain Current	I_{DM}	20	A
Total Power Dissipation	$P_D @ T_C = 25$	3.6	W
Total Power Dissipation	$P_D @ T_A = 25$	0.69	W
Operating Junction Temperature	T_J	-55 to 150	
Storage Temperature	T_{STG}	-55 to 150	
Single Pulse Avalanche Energy	E_{AS}	45	mJ

P Channel Absolute Maximum Ratings $T_C = 25$

Parameter	Symbol	Rating	Unit
Drain-Source Voltage	V_{DS}	-30	V
Gate-Source Voltage	V_{GS}	± 20	V
Continuous Drain Current	$I_D @ T_C = 25$	-7	A
	$I_D @ T_C = 75$	-5.3	A
	$I_D @ T_C = 100$	-4.4	A
Pulsed Drain Current	I_{DM}	-21	A
Total Power Dissipation	$P_D @ T_C = 25$	3.6	W
Total Power Dissipation	$P_D @ T_A = 25$	0.69	W
Operating Junction Temperature	T_J	-55 to 150	
Storage Temperature	T_{STG}	-55 to 150	
Single Pulse Avalanche Energy	E_{AS}	35	mJ

Thermal resistance

Parameter	Symbol	Min.	Typ.	Max.	Unit
Thermal resistance, junction - case	R_{thJC}	-	-	34	$^{\circ}C/W$
Thermal resistance, junction - ambient	R_{thJA}	-	-	180	$^{\circ}C/W$
Soldering temperature, wavesoldering for 10s	T_{sold}	-	-	265	$^{\circ}C$

N Channel Electronic Characteristics

Parameter	Symbol	Condition	Min.	Typ.	Max.	Unit
Drain-Source Breakdown Voltage	BV_{DSS}	$V_{GS} = 0V, I_D = 250\mu A$	30			V
Gate Threshold Voltage	$V_{GS(TH)}$	$V_{GS} = V_{DS}, I_D = 250\mu A$	1.2	1.6	2.5	V
Drain-Source Leakage Current	I_{DSS}	$V_{DS} = 30V, V_{GS} = 0V$			1.0	μA
Gate- Source Leakage Current	I_{GSS}	$V_{GS} = \pm 20V, V_{DS} = 0V$			100	nA
Static Drain-source On Resistance		$V_{GS} = 10V, I_D = 6A$				
		$V_{GS} = 4.5V, I_D = 4A$				
Forward Transconductance	g_{FS}	$V_{DS} = 25V, I_D = 5A$				
Source-drain voltage	V_{SD}	$I_S = 6A$				

N Channel characteristics curve

Fig.1 Power Dissipation

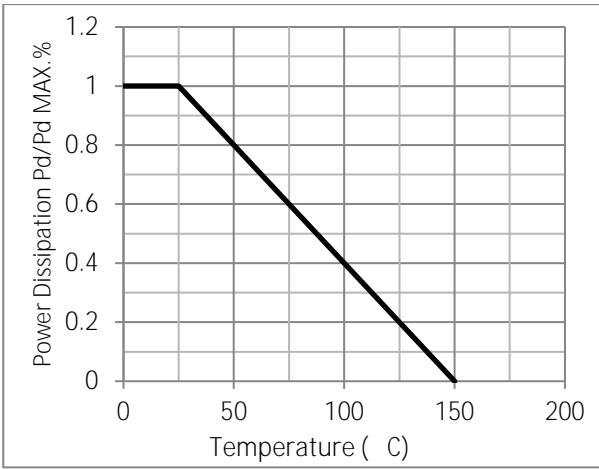

Fig.2 Typical output Characteristics

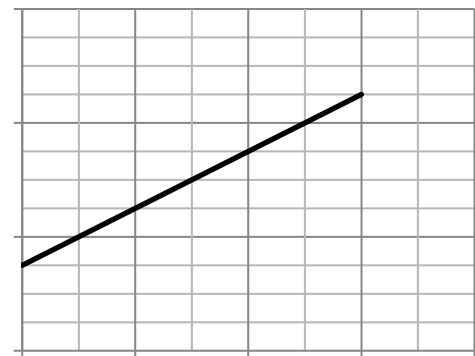

Fig.3 Threshold Voltage V.S Junction Temperature

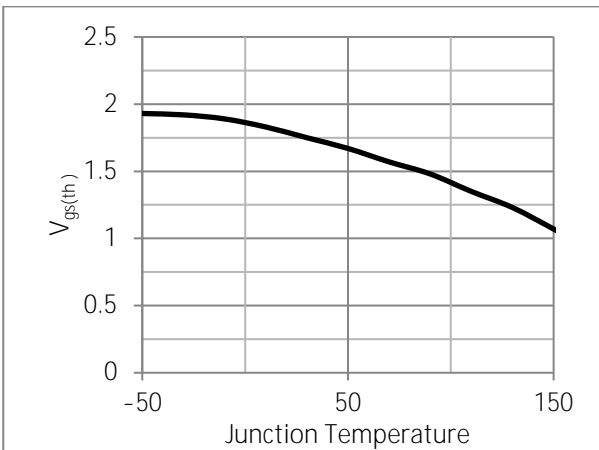
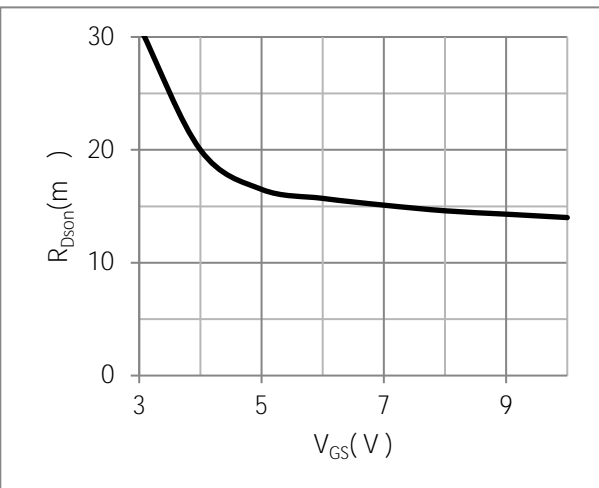

Fig.4 Resistance V.S Drain Current





Test Circuit

Fig.1 Switching Time Measurement Circuit

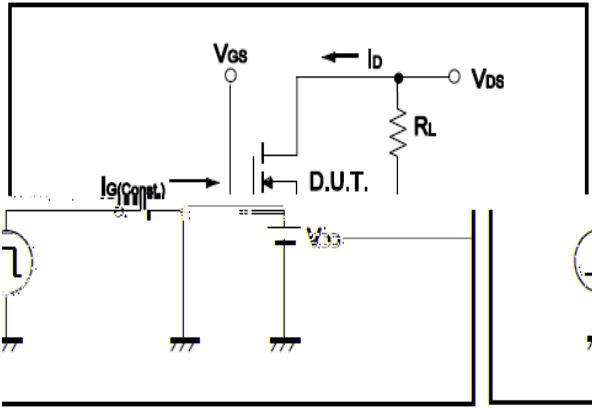

Fig.2 Gate Charge Waveform

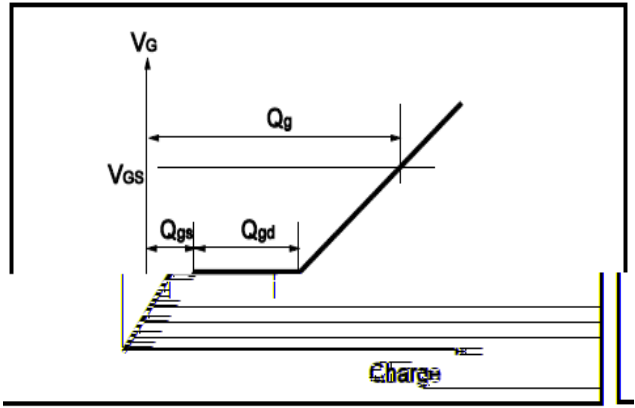

Fig.3 Switching Time Measurement Circuit

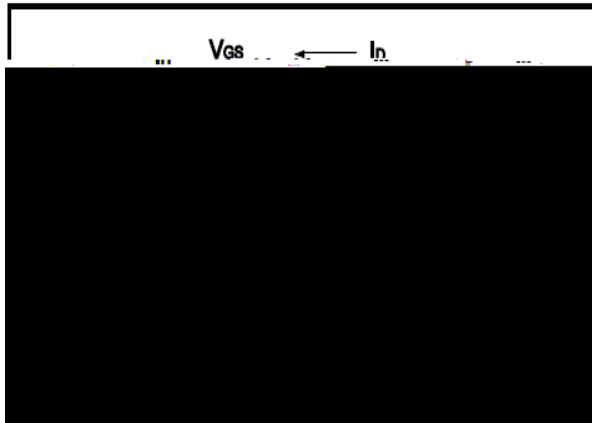

Fig.4 Gate Charge Waveform

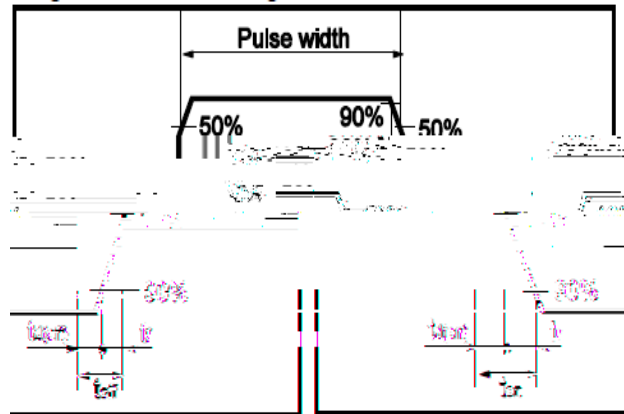

Fig.5 Avalanche Measurement Circuit

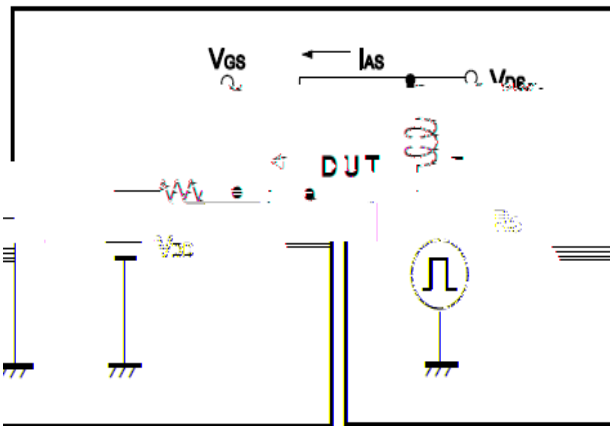
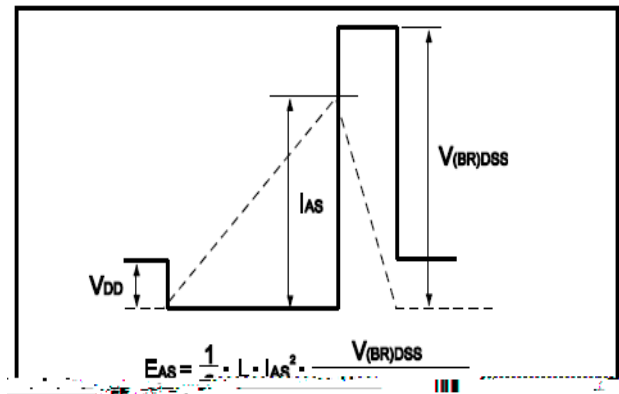

Fig.6 Avalanche Waveform



Dimensions(SOP8)

Unit: mm

SYMBOL	min	TYP	max	SYMBOL	min		max
A	4.80		5.25	C	1.30		1.75
A1	0.37		0.49	C1	0.55		0.75
A2		1.27		C2	0.55		0.65
A3		0.41		C3	0.05		0.20
B	5.80		6.20	C4	0.10	0.20	0.23
B1	3.80		4.10	D		1.05	
B2		5.00		D1	0.40		0.62

