

General Description

It combines advanced trench MOSFET technology with a low resistance package to provide extremely low $R_{DS(ON)}$. This device is ideal for switch and battery protection applications.

Features

density Trench technology
 $R_{DS(ON)}$ to minimize conductive loss

Application

nd Synchronous Rectifier

Product Summary

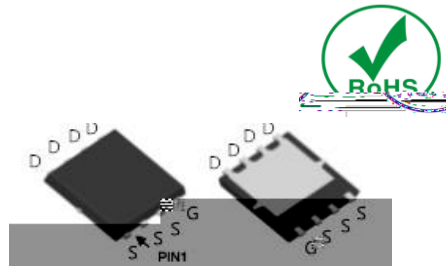

Ordering Information:

	3000

Absolute Maximum Ratings $T_C = 25$

Parameter	Symbol	Rating	Unit
Drain-Source Voltage	V_{DS}	30	V
Gate-Source Voltage	V_{GS}	± 20	V
Continuous Drain Current	$I_{D@T_C=25}$	105	A
	$I_{D@T_C=75}$	80	A
	$I_{D@T_C=100}$	66	A
	$I_{D@T_A=25}$	35	A
	$I_{D@T_A=70}$	28	A
Pulsed Drain Current	I_{DM}	315	A
Total Power Dissipation	$P_D@T_C=25$	65.7	W
Total Power Dissipation	$P_D@T_A=25$	2.5	W
Operating Junction Temperature	T_J	-55 to 150	
Storage Temperature	T_{STG}	-55 to 150	
Single Pulse Avalanche Energy	E_{AS}	120	mJ



Thermal resistance

Parameter	Symbol	Min.	Typ.	Max.	Unit
-----------	--------	------	------	------	------

Fig.1 Power Dissipation

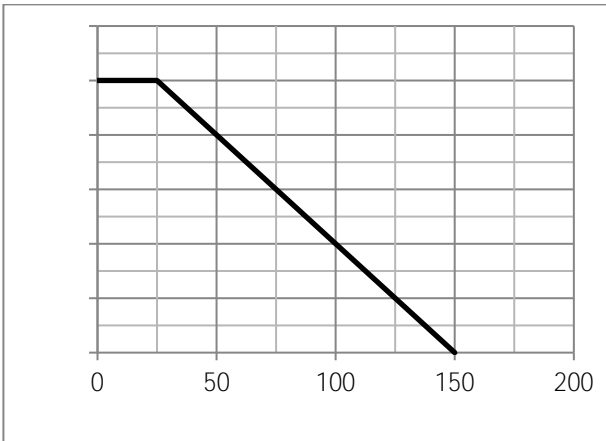

Fig.2 Typical output Characteristics

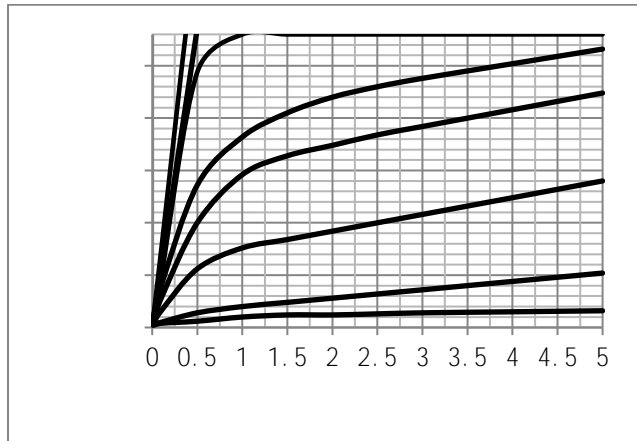

Fig.3 Threshold Voltage V.S Junction Temperature

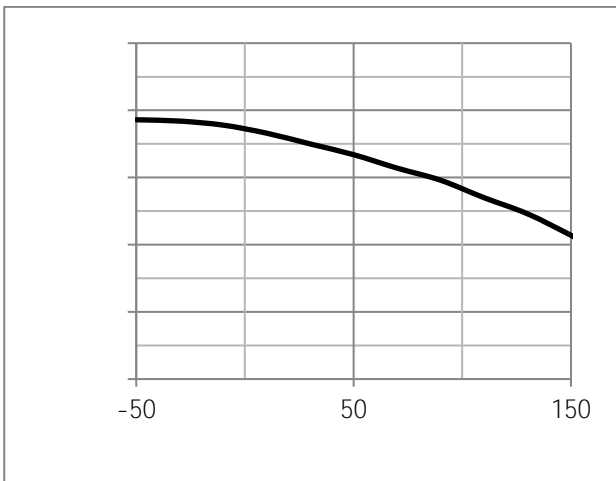

Fig.4 Resistance V.S Drain Current

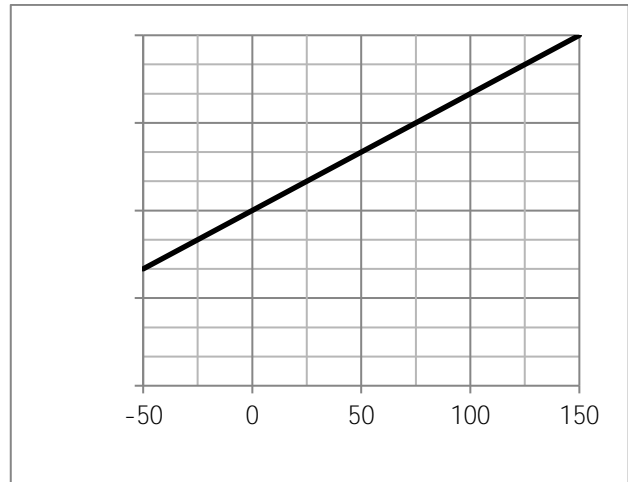
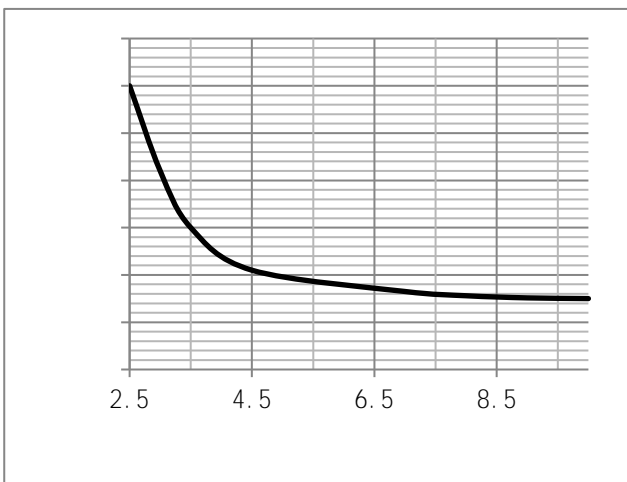
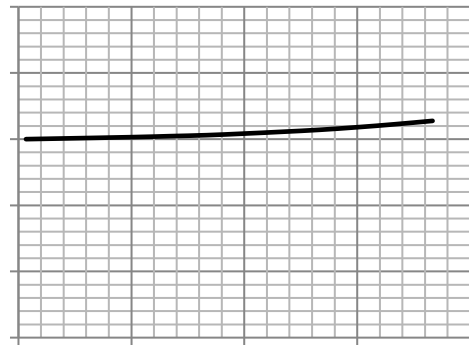





Fig.14 Switching Time Measurement Circuit

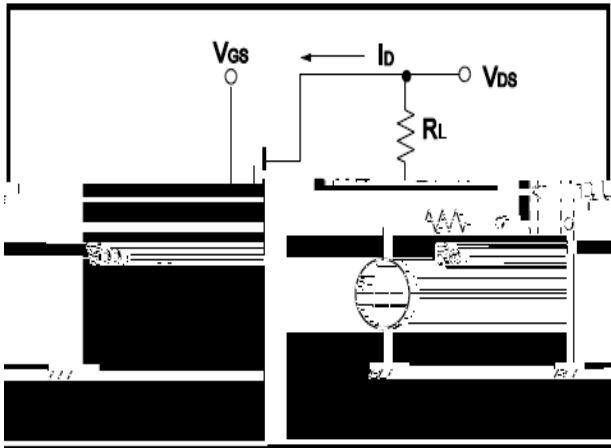

Fig.15 Gate Charge Waveform

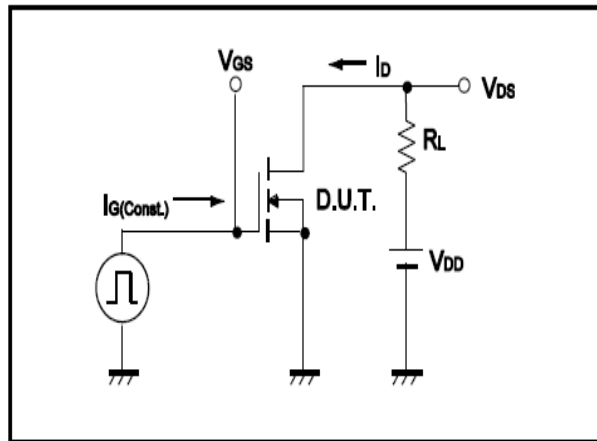

Fig.16 Avalanche Measurement Circuit

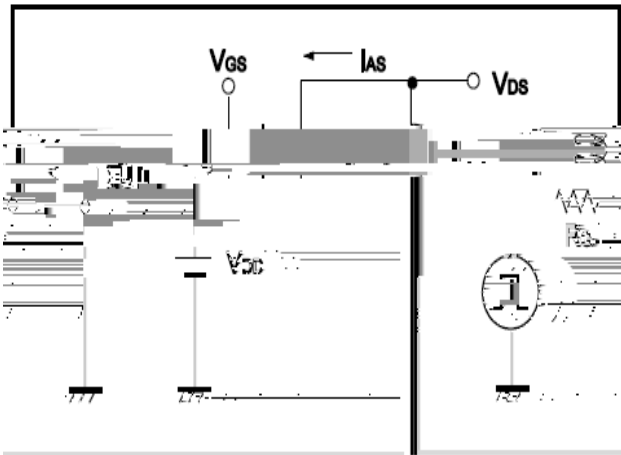

Fig.17 Avalanche Waveform

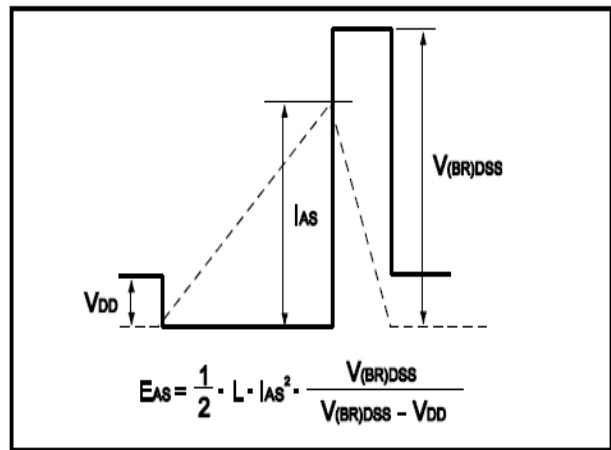
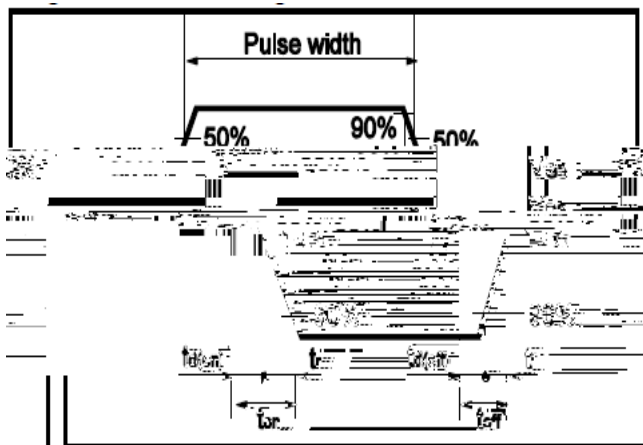

Fig.18 Gate Charge Waveform





Dimensions DFN5x6

Unit mm

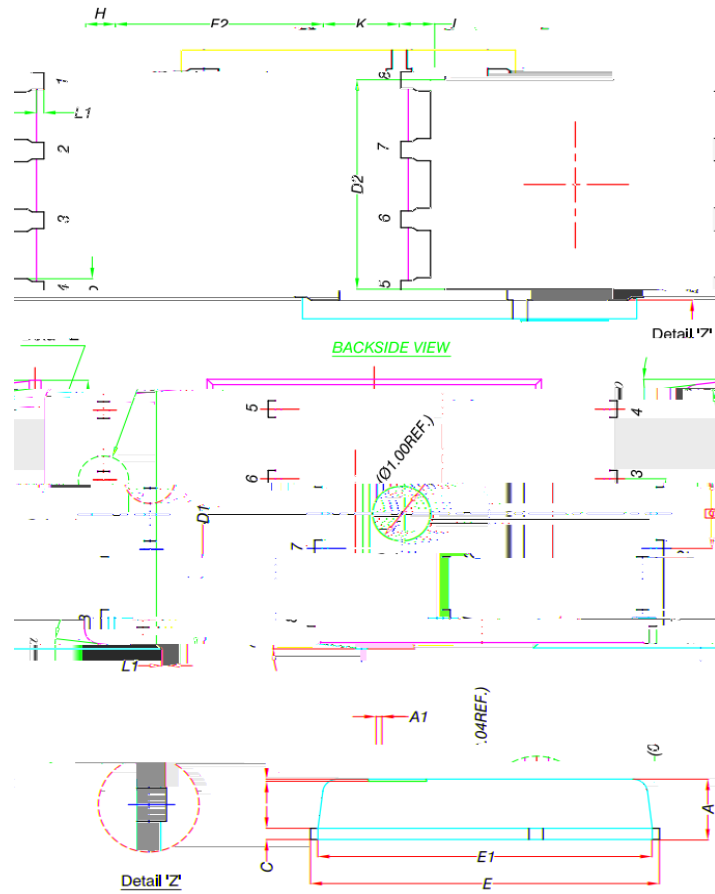

DIM.	MILLIMETERS		
	MIN.	NOM.	MAX.
A	0.90	1.00	1.10
A1	0	-	0.05
b	0.33	0.41	0.51
C	0.20	0.25	0.30
D1	4.80	4.90	5.00
D2	3.61	3.81	3.96

